

Loadline YM and YS

Moulded Case Circuit Breakers

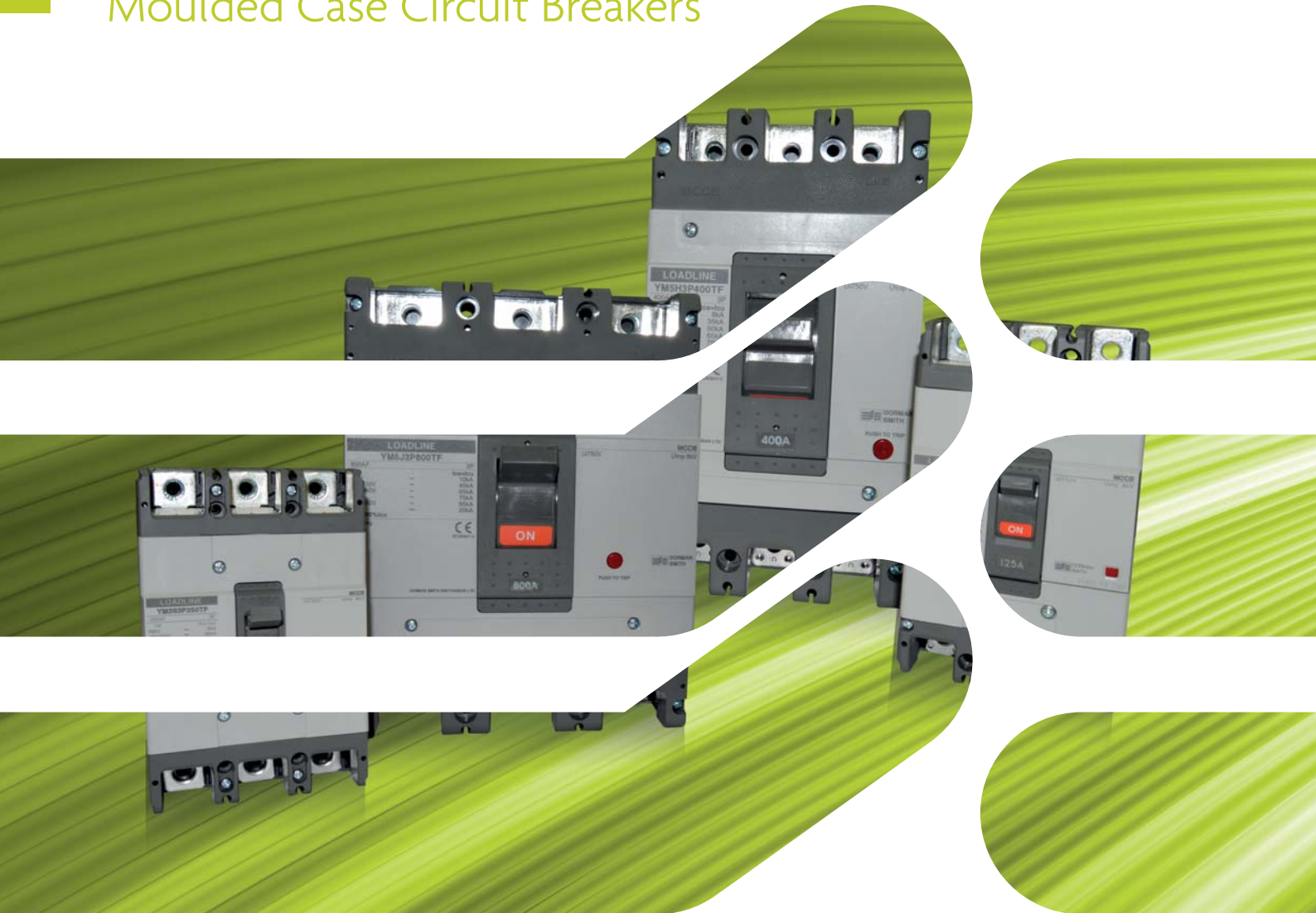

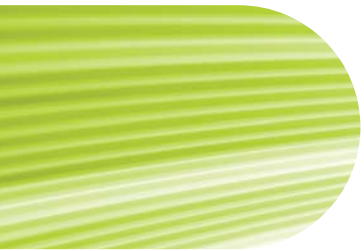

Dorman Smith Switchgear Limited

With over 130 years of experience in switchgear design and production Dorman Smith Switchgear Limited continues to provide high quality equipment for low-voltage electrical distribution and circuit protection.

Our product range begins with single-pole and neutral distribution board systems and continues up to custom designed, factory built low-voltage electrical switchboards for a broad range of commercial, industrial and retrofit applications.

We continue to build on our extensive technical knowledge and awareness of customer and market demands, operating conditions and current regulations.

This breadth of experience supports the development and manufacturing techniques of our electrical products to exceed the industry standards.

Index

Content	Page No
Loadline YM1 Frame MCCB	2
Loadline YM2 Frame MCCB	3
Loadline YM3 Frame MCCB	4
Loadline YM1, YM2 & YM3 Frame MCCB Accessories	5
Loadline YM5 Frame MCCB	6
Loadline YM6 Frame MCCB	7
Loadline YM5 & YM6 Frame MCCB Accessories	8
Loadline YS2 Frame MCCB	9-11
Loadline YS3 Frame MCCB	12-15
Loadline YS5 Frame MCCB	16-17
Loadline YS6 Frame MCCB	18-19
Loadline YS2 to YS6 Frame MCCB Accessories	20-21
Loadline YS8 Frame MCCB & Accessories	22-25
Loadline YM Frame MCCB Technical Data	26-29
Loadline YS Frame MCCB Technical Data	30-37

Loadline

YM MCCB

Loadline MCCB

YM1 Frame



Main Features

- Exceeds the requirements of EN 60947-2
- MCCBs have fixed thermal and fixed instantaneous trips
- Ultimate breaking capacities of 18kA and 26kA at 415/460V AC
- Ics = 100% Icu for 18kA devices and Ics = 75% Icu for 26kA devices
- MCCBs have front connection terminals as standard
- Rated Operational Voltage is 690V AC (Ue)
- Rated Insulation Voltage is 750V AC (Ui)
- Fully rated for use at 50°C

Current Rating (A)	2-Pole Product Code	3-Pole Product Code	4-Pole Product Code
YM1 Frame MCCB Fixed Thermal / Magnetic, Icu = 18kA			
15	YM1B2P15TF	YM1B3P15TF	YM1B4P15TF
20	YM1B2P20TF	YM1B3P20TF	YM1B4P20TF
30	YM1B2P30TF	YM1B3P30TF	YM1B4P30TF
40	YM1B2P40TF	YM1B3P40TF	YM1B4P40TF
50	YM1B2P50TF	YM1B3P50TF	YM1B4P50TF
60	YM1B2P60TF	YM1B3P60TF	YM1B4P60TF
75	YM1B2P75TF	YM1B3P75TF	YM1B4P75TF
100	YM1B2P100TF	YM1B3P100TF	YM1B4P100TF
YM1 Frame MCCB Fixed Thermal / Magnetic, Icu = 26kA			
15	YM1N2P15TF	YM1N3P15TF	YM1N4P15TF
20	YM1N2P20TF	YM1N3P20TF	YM1N4P20TF
30	YM1N2P30TF	YM1N3P30TF	YM1N4P30TF
40	YM1N2P40TF	YM1N3P40TF	YM1N4P40TF
50	YM1N2P50TF	YM1N3P50TF	YM1N4P50TF
60	YM1N2P60TF	YM1N3P60TF	YM1N4P60TF
75	YM1N2P75TF	YM1N3P75TF	YM1N4P75TF
100	YM1N2P100TF	YM1N3P100TF	YM1N4P100TF

YM1 Frame Dimensions

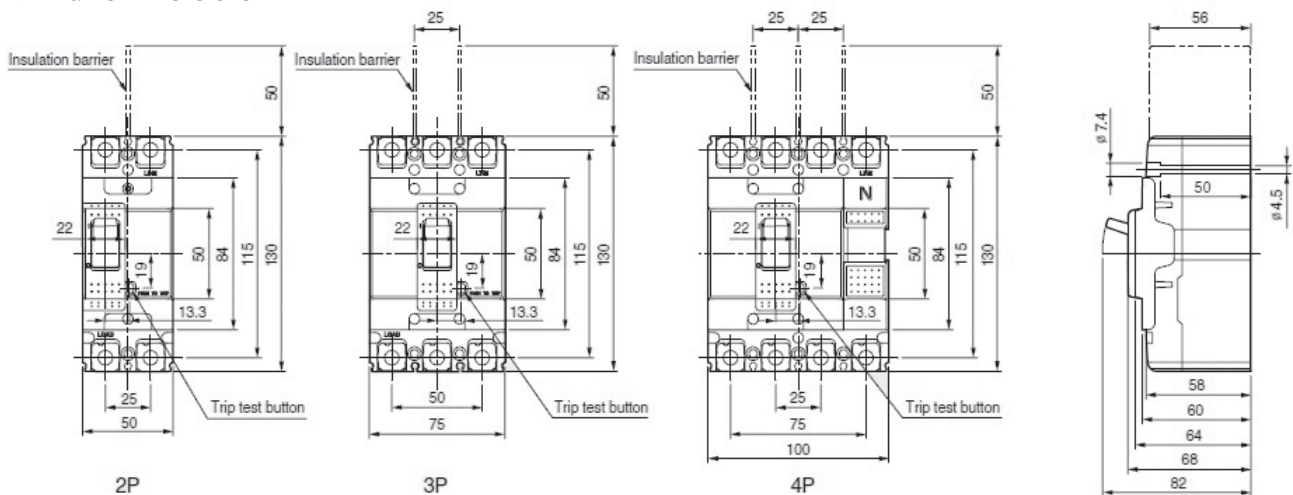

Loadline MCCB

YM2 Frame

Loadline

YM MCCB

Main Features

- Exceeds the requirements of EN 60947-2
- MCCBs have fixed thermal and fixed instantaneous trips
- Ultimate breaking capacities of 37kA at 415/460V AC
- Ics = 100% Icu for all ratings
- MCCBs have front connection terminals as standard
- Rated Operational Voltage is 690V AC (Ue)
- Rated Insulation Voltage is 750V AC (Ui)
- Fully rated for use at 50°C



Current Rating (A)	2-Pole Product Code	3-Pole Product Code	4-Pole Product Code
YM2 Frame MCCB Fixed Thermal / Magnetic, Icu = 37kA			
15	YM2S2P15TF	YM2S3P15TF	YM2S4P15TF
20	YM2S2P20TF	YM2S3P20TF	YM2S4P20TF
30	YM2S2P30TF	YM2S3P30TF	YM2S4P30TF
40	YM2S2P40TF	YM2S3P40TF	YM2S4P40TF
50	YM2S2P50TF	YM2S3P50TF	YM2S4P50TF
60	YM2S2P60TF	YM2S3P60TF	YM2S4P60TF
75	YM2S2P75TF	YM2S3P75TF	YM2S4P75TF
100	YM2S2P100TF	YM2S3P100TF	YM2S4P100TF
125	YM2S2P125TF	YM2S3P125TF	YM2S4P125TF

YM2 Frame Dimensions

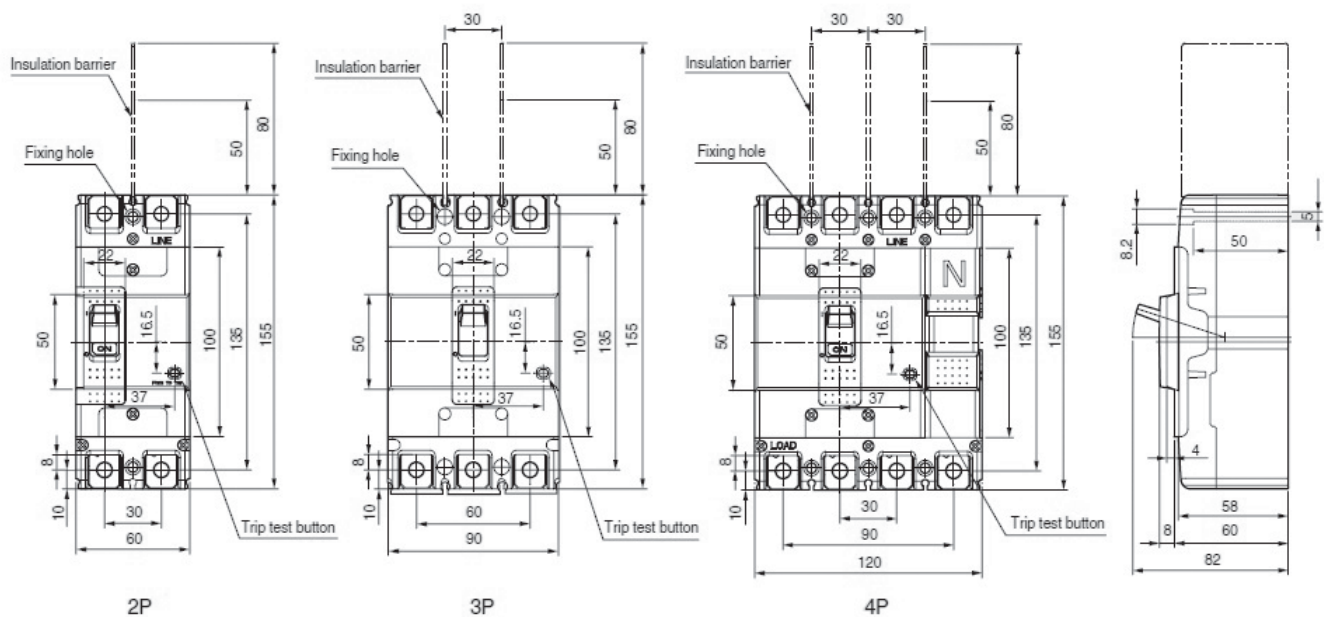

Loadline

YM MCCB

Loadline MCCB

YM3 Frame



Main Features

- Exceeds the requirements of EN 60947-2
- MCCBs have fixed thermal and fixed instantaneous trips
- Ultimate breaking capacities are 26kA and 37kA at 415/460V AC
- Ics = 100% Icu for all ratings
- MCCBs have front connection terminals as standard
- Rated Operational Voltage is 690V AC (Ue)
- Rated Insulation Voltage is 750V AC (Ui)
- Fully rated for use at 50°C

Current Rating (A)	2-Pole Product Code	3-Pole Product Code	4-Pole Product Code
YM3 Frame MCCB Fixed Thermal / Magnetic, Icu = 26kA			
100	YM3N2P100TF	YM3N3P100TF	YM3N4P100TF
125	YM3N2P125TF	YM3N3P125TF	YM3N4P125TF
150	YM3N2P150TF	YM3N3P150TF	YM3N4P150TF
175	YM3N2P175TF	YM3N3P175TF	YM3N4P175TF
200	YM3N2P200TF	YM3N3P200TF	YM3N4P200TF
225	YM3N2P225TF	YM3N3P225TF	YM3N4P225TF
250	YM3N2P250TF	YM3N3P250TF	YM3N4P250TF
YM3 Frame MCCB Fixed Thermal / Magnetic, Icu = 37kA			
100	YM3S2P100TF	YM3S3P100TF	YM3S4P100TF
125	YM3S2P125TF	YM3S3P125TF	YM3S4P125TF
150	YM3S2P150TF	YM3S3P150TF	YM3S4P150TF
175	YM3S2P175TF	YM3S3P175TF	YM3S4P175TF
200	YM3S2P200TF	YM3S3P200TF	YM3S4P200TF
225	YM3S2P225TF	YM3S3P225TF	YM3S4P225TF
250	YM3S2P250TF	YM3S3P250TF	YM3S4P250TF

YM3 Frame Dimensions

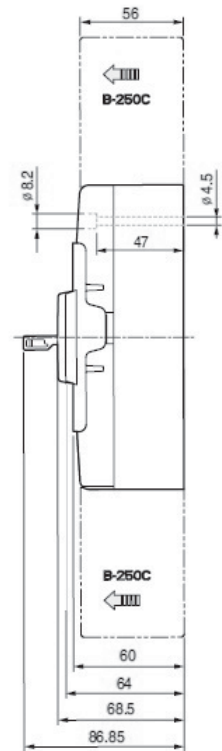
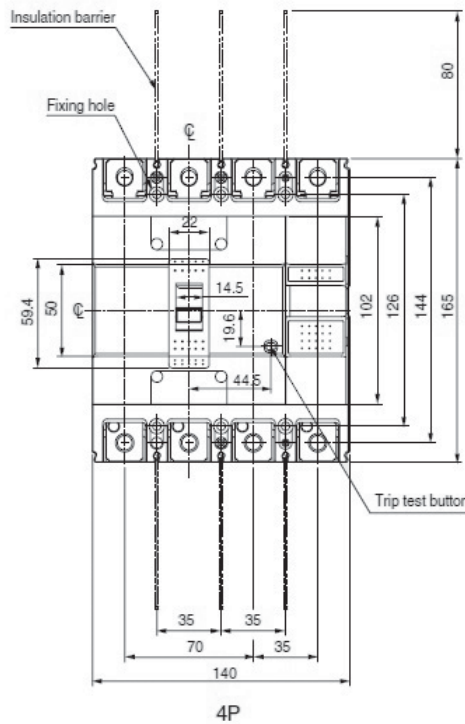
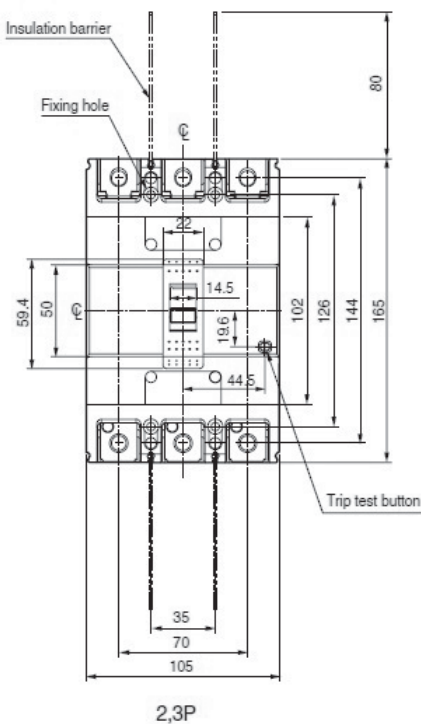

Loadline MCCB

YM1, YM2 and YM3 Frame accessories

Loadline YM MCCB

Description	2-Pole Product Code	3-Pole Product Code	4-Pole Product Code
Extension Terminals			
YM1 Flat Extension Terminals (Straight Type)	YM1XT2P	YM1XT3P	YM1XT4P
YM2 Flat Extension Terminals (Straight Type)	YM2XT2P	YM2XT3P	YM2XT4P
YM3 Flat Extension Terminals (Straight Type)	YM3XT2P	YM3XT3P	YM3XT4P
Rear Terminals			
YM1 Rear Terminals (Round Type)	YM1RT2P	YM1RT3P	YM1RT4P
YM2 Rear Terminals (Round Type)	YM2RT2P	YM2RT3P	YM2RT4P
YM3 Rear Terminals (Round Type)	YM3RT2P	YM3RT3P	YM3RT4P
Rotary Handles			
YM1 Direct Mounted Rotary Handle IP40		YM1DH	
YM2 Direct Mounted Rotary Handle IP40		YM2DH	
YM1 Direct Mounted Rotary Handle with Key Lock IP40		YM1DHK	
YM2 Direct Mounted Rotary Handle with Key Lock IP40		YM2DHK	
YM1 Door Mounted Rotary Handle IP65 (574 mm)		YM1RH2	
YM2 Door Mounted Rotary Handle IP65 (574 mm)		YM2RH2	
YM3 Direct Mounted Rotary Handle IP40		YM3DH	
YM3 Direct Mounted Rotary Handle with Key Lock IP40		YM3DHK	
YM3 Door Mounted Rotary Handle IP65 (572 mm)		YM3RH2	
Terminal Protection			
YM1 / YM2 Terminal Cover (Short)	YM12TCS2P	YM12TCS3P	YM12TCS4P
YM1 / YM2 Terminal Cover (Long)	YM12TCL2P	YM12TCL3P	YM12TCL4P
YM3 Terminal Cover (Short)	YM3TCS3P	YM3TCS3P	YM3TCS4P
YM3 Terminal Cover (Long)	YM3TCL3P	YM3TCL3P	YM3TCL4P
YM1 / YM2 Interphase barrier (1 off)		YM12TB	
YM3 Interphase barrier (1 off)		YM3TB	
Plug-in Base			
YM1 Plug-In Base IP20 for 3-Pole		YM1PB3P	
YM2 Plug-In Base IP20 for 3-Pole		YM2PB3P	
YM3 Plug-In Base IP20 for 3-Pole		YM3PB3P	
Auxiliary and Alarm Switches *			
YM Auxiliary switch Micro 1C (General purpose - Left)		YMAUX1-L	
YM Auxiliary switch Micro 1C (General purpose - Right)		YMAUX1-R	
YM Alarm switch Micro 1C (General purpose - Left)		YMAL-L	
YM Alarm switch Micro 1C (General purpose - Right)		YMAL-R	
YM1-YM3 Auxiliary and Alarm switch (General Purpose - Left)		YM13AUXAL-L	
YM1-YM3 Auxiliary and Alarm switch (General Purpose - Right)		YM13AUXAL-R	
Shunt Trip *			
YM1-YM3 Shunt Trip 100-130V AC		YM13ST130AC	
YM1-YM3 Shunt Trip 200-250V AC		YM13ST250AC	
YM1-YM3 Shunt Trip 380-450V AC		YM13ST450AC	
YM1-YM3 Shunt Trip 24V DC		YM13ST24DC	
YM1-YM3 Shunt Trip 48V DC		YM13ST48DC	
YM1-YM3 Shunt Trip 100-130V DC		YM13ST130DC	
YM1-YM3 Shunt Trip 200-250V DC		YM13ST250DC	
Under-voltage Release *			
YM1-YM3 Under-voltage release 100-110V AC		YM13UVR110AC	
YM1-YM3 Under-voltage release 200-220V AC		YM13UVR220AC	
YM1-YM3 Under-voltage release 380-440V AC		YM13UVR440AC	
YM1-YM3 Under-voltage release 24V DC		YM13UVR24DC	
YM1-YM3 Under-voltage release 48V DC		YM13UVR48DC	
YM1-YM3 Under-voltage release 100-110V DC		YM13UVR110DC	
YM1-YM3 Under-voltage release 200-220V DC		YM13UVR220DC	



Note: Please be advised that the MCCB can be fitted with either a Shunt Trip or an Under-voltage release device, however the MCCB cannot house both of these devices together.

* Common Accessories for YM1, YM2 & YM3 frame MCCBs

Loadline

YM MCCB

Loadline MCCB

YM5 Frame



Main Features

- Exceeds the requirements of EN 60947-2
- MCCBs have fixed thermal and fixed instantaneous trips
- Ultimate breaking capacities are 37kA and 50kA at 415/460V AC
- Ics = 100% Icu for all ratings
- MCCBs have front connection terminals as standard
- Rated Operational Voltage is 690V AC (Ue)
- Rated Insulation Voltage is 750V AC (Ui)
- Fully rated for use at 50°C

Current Rating (A)	3-Pole Product Code	4-Pole Product Code
YM5 Frame MCCB Fixed Thermal / Magnetic, Icu = 37kA		
250	YM5S3P250TF	YM5S4P250TF
300	YM5S3P300TF	YM5S4P300TF
350	YM5S3P350TF	YM5S4P350TF
400	YM5S3P400TF	YM5S4P400TF
YM5 Frame MCCB Fixed Thermal / Magnetic, Icu = 50kA		
250	YM5H3P250TF	YM5H4P250TF
300	YM5H3P300TF	YM5H4P300TF
350	YM5H3P350TF	YM5H4P350TF
400	YM5H3P400TF	YM5H4P400TF

YM5 Frame Dimensions

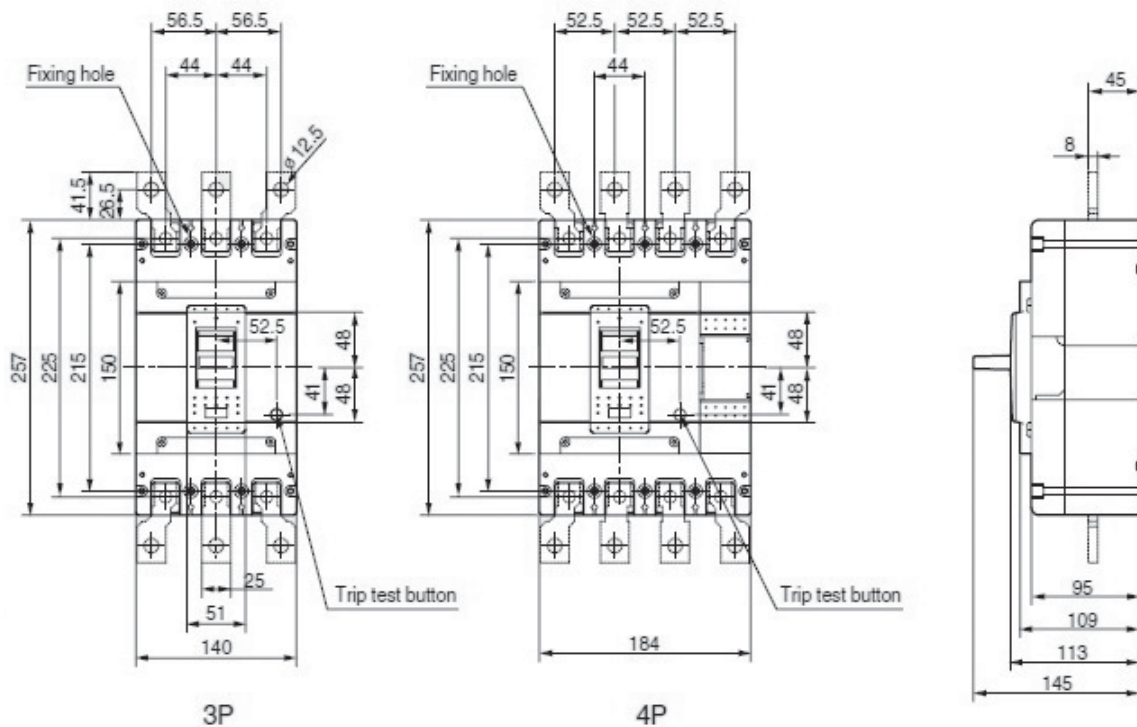

Loadline MCCB

YM6 Frame

Loadline

YM MCCB

Main Features

- Exceeds the requirements of EN 60947-2
- MCCBs have fixed thermal and fixed instantaneous trips
- Ultimate breaking capacities are 37kA and 65kA at 415/460V AC
- $I_{cs} = 100\% I_{cu}$ for all ratings
- MCCBs have front connection terminals as standard
- Rated Operational Voltage is 690V AC (U_e)
- Rated Insulation Voltage is 750V AC (U_i)
- Fully rated for use at 50°C



Current Rating (A)	3-Pole Product Code	4-Pole Product Code
YM6 Frame MCCB Fixed Thermal / Magnetic, $I_{cu} = 37kA$		
500	YM6S3P500TF	YM6S4P500TF
630	YM6S3P630TF	YM6S4P630TF
700	YM6S3P700TF	YM6S4P700TF
800	YM6S3P800TF	YM6S4P800TF
YM6 Frame MCCB Fixed Thermal / Magnetic, $I_{cu} = 65kA$		
500	YM6J3P500TF	YM6J4P500TF
630	YM6J3P630TF	YM6J4P630TF
700	YM6J3P700TF	YM6J4P700TF
800	YM6J3P800TF	YM6J4P800TF

YM6 Frame Dimensions

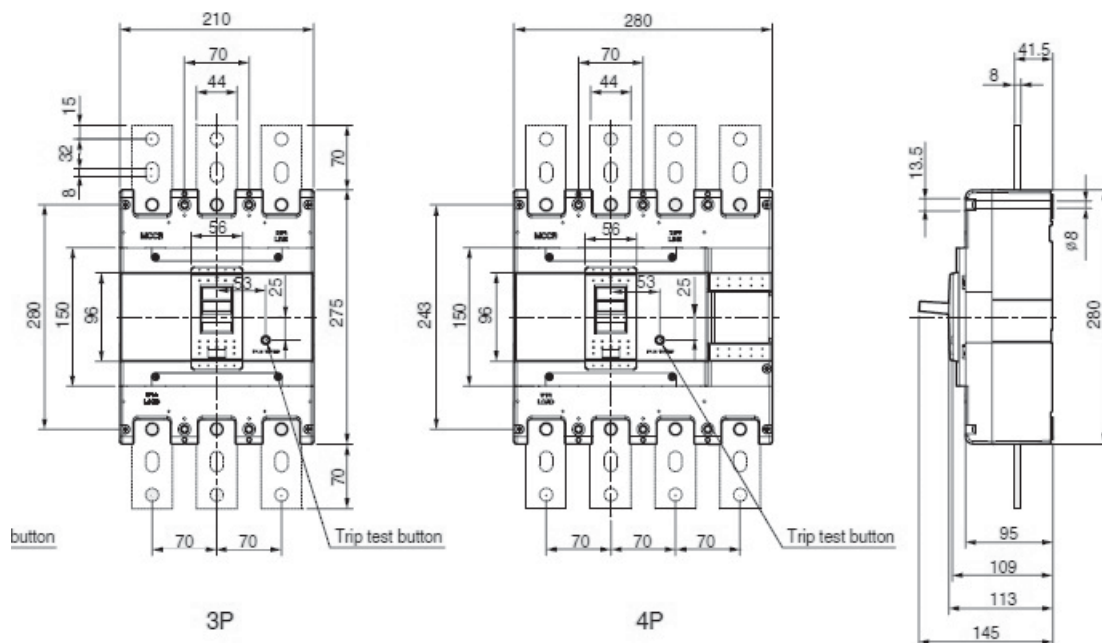

Loadline

YM MCCB

Loadline MCCB

YM5 and YM6 Frame accessories



Description	3-Pole Product Code	4-Pole Product Code
Extension Terminals		
YM5 Flat Extension Terminals (Straight Type)	YM5XT3P	YM5XT4P
YM6 Flat Extension Terminals (Straight Type)	YM6XT3P	YM6XT4P
Rotary Handles		
YM5 Direct mounted rotary handle IP40	YM5DH	
YM5 Door mounted rotary handle IP65 (396 mm)	YM5RH2	
YM6 Direct mounted rotary handle IP40	YM6DH	
YM6 Door mounted rotary handle IP65 (396 mm)	YM6RH2	
Terminal Protection		
YM5 Terminal Cover (Long)	YM5TCL3P	YM5TCL4P
YM6 Terminal Cover (Long)	YM6TCL3P	YM6TCL4P
YM5 Interphase barrier (1 off)	YM5TB	
YM6 Interphase barrier (1 off)	YM6TB	
Mechanical Interlock		
YM5 Mechanical Interlock Plate (Narrow)	YM5MI3PLN	YM5MI4PLN
YM5 Mechanical Interlock Plate (Wide)	YM5MI3PLW	YM5MI4PLW
YM6 Mechanical Interlock Plate (Narrow)	YM6MI3PLN	YM6MI4PLN
YM6 Mechanical Interlock Plate (Wide)	YM6MI3PLW	YM6MI4PLW
Plug-in Base		
YM5 Plug-In Base IP20 for 3-Pole	YM5PB3P	
YM6 Plug-In Base IP20 for 3-Pole	YM6PB3P	
Auxiliary and Alarm Switches *		
YM Auxiliary switch Micro 1C (General purpose - Left)	YMAUX1-L	
YM Auxiliary switch Micro 1C (General purpose - Right)	YMAUX1-R	
YM Alarm switch Micro 1C (General purpose - Left)	YMAL-L	
YM Alarm switch Micro 1C (General purpose - Right)	YMAL-R	
Shunt Trip *		
YM5 / YM6 Shunt Trip 100-125V AC	YM56ST125AC	
YM5 / YM6 Shunt Trip 200-240V AC	YM56ST240AC	
YM5 / YM6 Shunt Trip 380-460V AC	YM56ST460AC	
YM5 / YM6 Shunt Trip 24V DC	YM56ST24DC	
YM5 / YM6 Shunt Trip 48V DC	YM56ST48DC	
YM5 / YM6 Shunt Trip 100-110V DC	YM56ST110DC	
YM5 / YM6 Shunt Trip 200-220V DC	YM56ST220DC	
Under-Voltage Release *		
YM5 / YM6 Under-voltage release 100-110V AC	YM56UVR110AC	
YM5 / YM6 Under-voltage release 200-220V AC	YM56UVR220AC	
YM5 / YM6 Under-voltage release 380-440V AC	YM56UVR440AC	
YM5 / YM6 Under-voltage release 24V DC	YM56UVR24DC	
YM5 / YM6 Under-voltage release 48V DC	YM56UVR48DC	
YM5 / YM6 Under-voltage release 100-110V DC	YM56UVR110DC	
YM5 / YM6 Under-voltage release 200-220V AC	YM56UVR220DC	

Note: Please be advised that the MCCB can be fitted with either a Shunt Trip or an Under-voltage release device, however the MCCB cannot house both of these devices together.

* Common Accessories for YM5 and YM6 frame MCCBs

Loadline MCCB YS2 Frame

Loadline YS MCCB

Main Features

- Exceeds the requirements of EN 60947-2
- MCCBs have fixed thermal and fixed instantaneous trips
- Ultimate breaking capacities of 50kA, 85kA and 150kA at 380/415V AC
- $I_{cs} = 100\% I_{cu}$ for all ratings
- MCCBs have front connection terminals as standard
- 4-pole Switch Disconnecter and MCCBs have the neutral on the left hand side
- Rated Operational Voltage is 690V AC (U_e)
- Rated Insulation Voltage is 750V AC (U_i)
- Fully rated for use at 50°C



Current Rating (A)	3-Pole Product Code	4-Pole (N-Left) Product Code
Switch Disconnecter		
160	YS2B3P160D	YS2B4PL160D
YS2 Frame MCCB Fixed Thermal / Magnetic, $I_{cu} = 50kA$		
16	YS2H3P16TF	YS2H4PL16TF
20	YS2H3P20TF	YS2H4PL20TF
25	YS2H3P25TF	YS2H4PL25TF
32	YS2H3P32TF	YS2H4PL32TF
40	YS2H3P40TF	YS2H4PL40TF
50	YS2H3P50TF	YS2H4PL50TF
63	YS2H3P63TF	YS2H4PL63TF
80	YS2H3P80TF	YS2H4PL80TF
100	YS2H3P100TF	YS2H4PL100TF
125	YS2H3P125TF	YS2H4PL125TF
160	YS2H3P160TF	YS2H4PL160TF
YS2 Frame MCCB Fixed Thermal / Magnetic, $I_{cu} = 85kA$		
16	YS2K3P16TF	YS2K4PL16TF
20	YS2K3P20TF	YS2K4PL20TF
25	YS2K3P25TF	YS2K4PL25TF
32	YS2K3P32TF	YS2K4PL32TF
40	YS2K3P40TF	YS2K4PL40TF
50	YS2K3P50TF	YS2K4PL50TF
63	YS2K3P63TF	YS2K4PL63TF
80	YS2K3P80TF	YS2K4PL80TF
100	YS2K3P100TF	YS2K4PL100TF
125	YS2K3P125TF	YS2K4PL125TF
160	YS2K3P160TF	YS2K4PL160TF
YS2 Frame MCCB Fixed Thermal / Magnetic, $I_{cu} = 150kA$		
16	YS2R3P16TF	YS2R4PL16TF
20	YS2R3P20TF	YS2R4PL20TF
25	YS2R3P25TF	YS2R4PL25TF
32	YS2R3P32TF	YS2R4PL32TF
40	YS2R3P40TF	YS2R4PL40TF
50	YS2R3P50TF	YS2R4PL50TF
63	YS2R3P63TF	YS2R4PL63TF
80	YS2R3P80TF	YS2R4PL80TF
100	YS2R3P100TF	YS2R4PL100TF
125	YS2R3P125TF	YS2R4PL125TF
160	YS2R3P160TF	YS2R4PL160TF

Loadline

YS MCCB

Loadline MCCB

YS2 Frame



Main Features

- Exceeds the requirements of EN 60947-2
- MCCBs have adjustable thermal and fixed instantaneous trips
- Ultimate breaking capacities of 50kA, 85kA and 150kA at 380/415V AC
- Ics = 100% Icu for all ratings
- MCCBs have front connection terminals as standard
- 4-pole MCCBs have the neutral on the left hand side
- Thermal adjustments are 0.8 x In, 0.9 x In and 1 x In
- Rated Operational Voltage is 690V AC (Ue)
- Rated Insulation Voltage is 750V AC (Ui)
- Fully rated for use at 50°C

Current Rating (A)	3-Pole Product Code	4-Pole (N-Left) Product Code
Switch Disconnector		
160	YS2B3P160D	YS2B4PL160D
YS2 Frame MCCB Adjustable Thermal / Magnetic, Icu = 50kA		
16	YS2H3P16TA	YS2H4PL16TA
20	YS2H3P20TA	YS2H4PL20TA
25	YS2H3P25TA	YS2H4PL25TA
32	YS2H3P32TA	YS2H4PL32TA
40	YS2H3P40TA	YS2H4PL40TA
50	YS2H3P50TA	YS2H4PL50TA
63	YS2H3P63TA	YS2H4PL63TA
80	YS2H3P80TA	YS2H4PL80TA
100	YS2H3P100TA	YS2H4PL100TA
125	YS2H3P125TA	YS2H4PL125TA
160	YS2H3P160TA	YS2H4PL160TA
YS2 Frame MCCB Adjustable Thermal / Magnetic, Icu = 85kA		
16	YS2K3P16TA	YS2K4PL16TA
20	YS2K3P20TA	YS2K4PL20TA
25	YS2K3P25TA	YS2K4PL25TA
32	YS2K3P32TA	YS2K4PL32TA
40	YS2K3P40TA	YS2K4PL40TA
50	YS2K3P50TA	YS2K4PL50TA
63	YS2K3P63TA	YS2K4PL63TA
80	YS2K3P80TA	YS2K4PL80TA
100	YS2K3P100TA	YS2K4PL100TA
125	YS2K3P125TA	YS2K4PL125TA
160	YS2K3P160TA	YS2K4PL160TA
YS2 Frame MCCB Adjustable Thermal / Magnetic, Icu = 150kA		
16	YS2R3P16TA	YS2R4PL16TA
20	YS2R3P20TA	YS2R4PL20TA
25	YS2R3P25TA	YS2R4PL25TA
32	YS2R3P32TA	YS2R4PL32TA
40	YS2R3P40TA	YS2R4PL40TA
50	YS2R3P50TA	YS2R4PL50TA
63	YS2R3P63TA	YS2R4PL63TA
80	YS2R3P80TA	YS2R4PL80TA
100	YS2R3P100TA	YS2R4PL100TA
125	YS2R3P125TA	YS2R4PL125TA
160	YS2R3P160TA	YS2R4PL160TA

Loadline MCCB

YS Frame MCCB Characteristics

Loadline
YS MCCB

YS2 Frame Dimensions

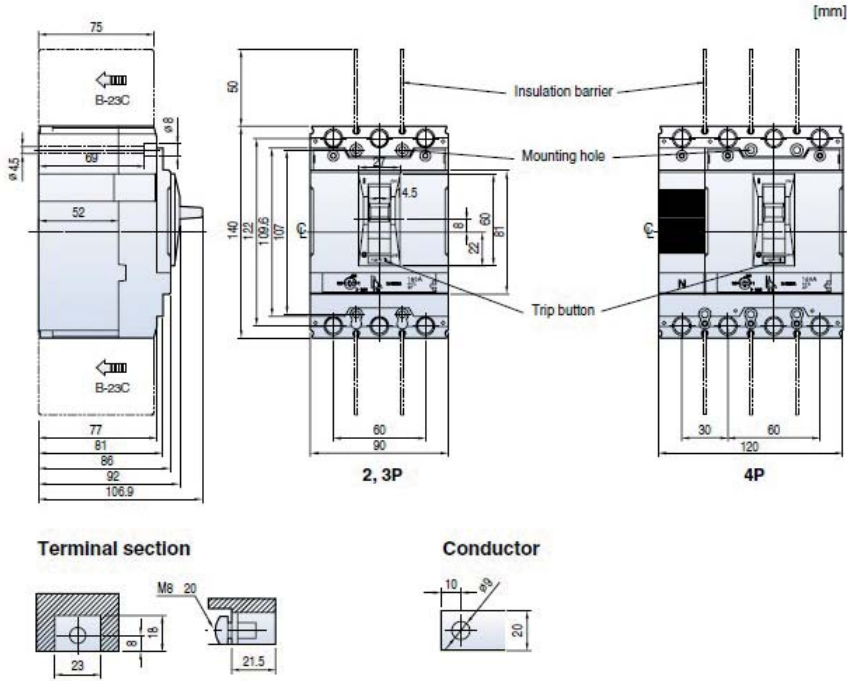

Loadline MCCB

YS3 Frame



Main Features

- Exceeds the requirements of EN 60947-2
- MCCBs have fixed thermal and fixed instantaneous trips
- Ultimate breaking capacities of 30kA, 50kA, 85kA and 150kA at 380/415V AC
- Ics = 100% Icu for all ratings
- MCCBs have front connection terminals as standard
- 4-pole Switch Disconnectors and MCCBs available with neutral on the left or right hand side
- Rated Operational Voltage is 690V AC (Ue)
- Rated Insulation Voltage is 750V AC (Ui)
- Fully rated for use at 50°C

Current Rating (A)	1-Pole (30kA) Product Code	3-Pole Product Code	4-Pole (N-Left) Product Code	4-Pole (N-Right) Product Code
Switch Disconnector				
100		YS3B3P100D	YS3B4PL100D	YS3B4PR100D
160		YS3B3P160D	YS3B4PL160D	YS3B4PR160D
250		YS3B3P250D	YS3B4PL250D	YS3B4PR250D
YS3 Frame MCCB Fixed Thermal / Magnetic, Icu = 30kA				
16	YS3N1P16TF			
25	YS3N1P25TF			
32	YS3N1P32TF			
40	YS3N1P40TF			
50	YS3N1P50TF			
63	YS3N1P63TF			
80	YS3N1P80TF			
100	YS3N1P100TF			
125	YS3N1P125TF			
160	YS3N1P160TF			
YS3 Frame MCCB Fixed Thermal / Magnetic, Icu = 50kA				
40		YS3H3P40TF	YS3H4PL40TF	YS3H4PR40TF
50		YS3H3P50TF	YS3H4PL50TF	YS3H4PR50TF
63		YS3H3P63TF	YS3H4PL63TF	YS3H4PR63TF
80		YS3H3P80TF	YS3H4PL80TF	YS3H4PR80TF
100		YS3H3P100TF	YS3H4PL100TF	YS3H4PR100TF
125		YS3H3P125TF	YS3H4PL125TF	YS3H4PR125TF
160		YS3H3P160TF	YS3H4PL160TF	YS3H4PR160TF
200		YS3H3P200TF	YS3H4PL200TF	YS3H4PR200TF
250		YS3H3P250TF	YS3H4PL250TF	YS3H4PR250TF
YS3 Frame MCCB Fixed Thermal / Magnetic, Icu = 85kA				
40		YS3K3P40TF	YS3K4PL40TF	YS3K4PR40TF
50		YS3K3P50TF	YS3K4PL50TF	YS3K4PR50TF
63		YS3K3P63TF	YS3K4PL63TF	YS3K4PR63TF
80		YS3K3P80TF	YS3K4PL80TF	YS3K4PR80TF
100		YS3K3P100TF	YS3K4PL100TF	YS3K4PR100TF
125		YS3K3P125TF	YS3K4PL125TF	YS3K4PR125TF
160		YS3K3P160TF	YS3K4PL160TF	YS3K4PR160TF
200		YS3K3P200TF	YS3K4PL200TF	YS3K4PR200TF
250		YS3K3P250TF	YS3K4PL250TF	YS3K4PR250TF
YS3 Frame MCCB Fixed Thermal / Magnetic, Icu = 150kA				
40		YS3R3P40TF	YS3R4PL40TF	YS3R4PR40TF
50		YS3R3P50TF	YS3R4PL50TF	YS3R4PR50TF
63		YS3R3P63TF	YS3R4PL63TF	YS3R4PR63TF
80		YS3R3P80TF	YS3R4PL80TF	YS3R4PR80TF
100		YS3R3P100TF	YS3R4PL100TF	YS3R4PR100TF
125		YS3R3P125TF	YS3R4PL125TF	YS3R4PR125TF
160		YS3R3P160TF	YS3R4PL160TF	YS3R4PR160TF
200		YS3R3P200TF	YS3R4PL200TF	YS3R4PR200TF
250		YS3R3P250TF	YS3R4PL250TF	YS3R4PR250TF

Loadline MCCB YS3 Frame

Loadline YS MCCB

Main Features

- Exceeds the requirements of EN 60947-2
- MCCBs have adjustable thermal and fixed instantaneous trips
- Ultimate breaking capacities of 50kA, 85kA and 150kA at 380/415V AC
- $I_{cs} = 100\% I_{cu}$ for all ratings
- MCCBs have front connection terminals as standard
- Thermal adjustments are $0.8 \times I_n$, $0.9 \times I_n$ and $1 \times I_n$
- 4-pole MCCBs available with neutral on the left or right hand side
- Rated Operational Voltage is 690V AC (U_e)
- Rated Insulation Voltage is 750V AC (U_i)
- Fully rated for use at 50°C



Current Rating (A)	3-Pole Product Code	4-Pole (N-Left) Product Code	4-Pole (N-Right) Product Code
YS3 Frame MCCB Adjustable Thermal / Fixed Magnetic, $I_{cu} = 50kA$			
40	YS3H3P40TA	YS3H4PL40TA	YS3H4PR40TA
50	YS3H3P50TA	YS3H4PL50TA	YS3H4PR50TA
63	YS3H3P63TA	YS3H4PL63TA	YS3H4PR63TA
80	YS3H3P80TA	YS3H4PL80TA	YS3H4PR80TA
100	YS3H3P100TA	YS3H4PL100TA	YS3H4PR100TA
125	YS3H3P125TA	YS3H4PL125TA	YS3H4PR125TA
160	YS3H3P160TA	YS3H4PL160TA	YS3H4PR160TA
200	YS3H3P200TA	YS3H4PL200TA	YS3H4PR200TA
250	YS3H3P250TA	YS3H4PL250TA	YS3H4PR250TA
YS3 Frame MCCB Adjustable Thermal / Fixed Magnetic, $I_{cu} = 85kA$			
40	YS3K3P40TA	YS3K4PL40TA	YS3K4PR40TA
50	YS3K3P50TA	YS3K4PL50TA	YS3K4PR50TA
63	YS3K3P63TA	YS3K4PL63TA	YS3K4PR63TA
80	YS3K3P80TA	YS3K4PL80TA	YS3K4PR80TA
100	YS3K3P100TA	YS3K4PL100TA	YS3K4PR100TA
125	YS3K3P125TA	YS3K4PL125TA	YS3K4PR125TA
160	YS3K3P160TA	YS3K4PL160TA	YS3K4PR160TA
200	YS3K3P200TA	YS3K4PL200TA	YS3K4PR200TA
250	YS3K3P250TA	YS3K4PL250TA	YS3K4PR250TA
YS3 Frame MCCB Adjustable Thermal / Fixed Magnetic, $I_{cu} = 150kA$			
40	YS3R3P40TA	YS3R4PL40TA	YS3R4PR40TA
50	YS3R3P50TA	YS3R4PL50TA	YS3R4PR50TA
63	YS3R3P63TA	YS3R4PL63TA	YS3R4PR63TA
80	YS3R3P80TA	YS3R4PL80TA	YS3R4PR80TA
100	YS3R3P100TA	YS3R4PL100TA	YS3R4PR100TA
125	YS3R3P125TA	YS3R4PL125TA	YS3R4PR125TA
160	YS3R3P160TA	YS3R4PL160TA	YS3R4PR160TA
200	YS3R3P200TA	YS3R4PL200TA	YS3R4PR200TA
250	YS3R3P250TA	YS3R4PL250TA	YS3R4PR250TA

Loadline

YS MCCB

Loadline MCCB

YS3 Frame



Main Features

- Exceeds the requirements of EN 60947-2
- MCCBs have adjustable thermal and adjustable instantaneous trips
- Ultimate breaking capacities of 50kA, 85kA and 150kA at 380/415V AC
- $I_{cs} = 100\% I_{cu}$ for all ratings
- MCCBs have front connection terminals as standard
- Thermal adjustments are $0.8 \times I_n$, $0.9 \times I_n$ and $1 \times I_n$
- Magnetic adjustments are between $5-10 \times I_n$
- 4-pole MCCBs available with neutral on the left or right hand side
- Rated Operational Voltage is 690V AC (Ue)
- Rated Insulation Voltage is 750V AC (Ui)
- Fully rated for use at 50°C

Current Rating (A)	3-Pole Product Code	4-Pole (N-Left) Product Code	4-Pole (N-Right) Product Code
YS3 Frame MCCB Adjustable Thermal / Adjustable Magnetic, Icu = 50kA			
125	YS3H3P125T	YS3H4PL125T	YS3H4PR125T
160	YS3H3P160T	YS3H4PL160T	YS3H4PR160T
200	YS3H3P200T	YS3H4PL200T	YS3H4PR200T
250	YS3H3P250T	YS3H4PL250T	YS3H4PR250T
YS3 Frame MCCB Adjustable Thermal / Fixed Magnetic, Icu = 85kA			
125	YS3K3P125T	YS3K4PL125T	YS3K4PR125T
160	YS3K3P160T	YS3K4PL160T	YS3K4PR160T
200	YS3K3P200T	YS3K4PL200T	YS3K4PR200T
250	YS3K3P250T	YS3K4PL250T	YS3K4PR250T
YS3 Frame MCCB Adjustable Thermal / Adjustable Magnetic, Icu = 150kA			
100	YS3R3P100T	YS3R4PL100T	YS3R4PR100T
125	YS3R3P125T	YS3R4PL125T	YS3R4PR125T
160	YS3R3P160T	YS3R4PL160T	YS3R4PR160T
200	YS3R3P200T	YS3R4PL200T	YS3R4PR200T
250	YS3R3P250T	YS3R4PL250T	YS3R4PR250T

YS3 Frame Dimensions

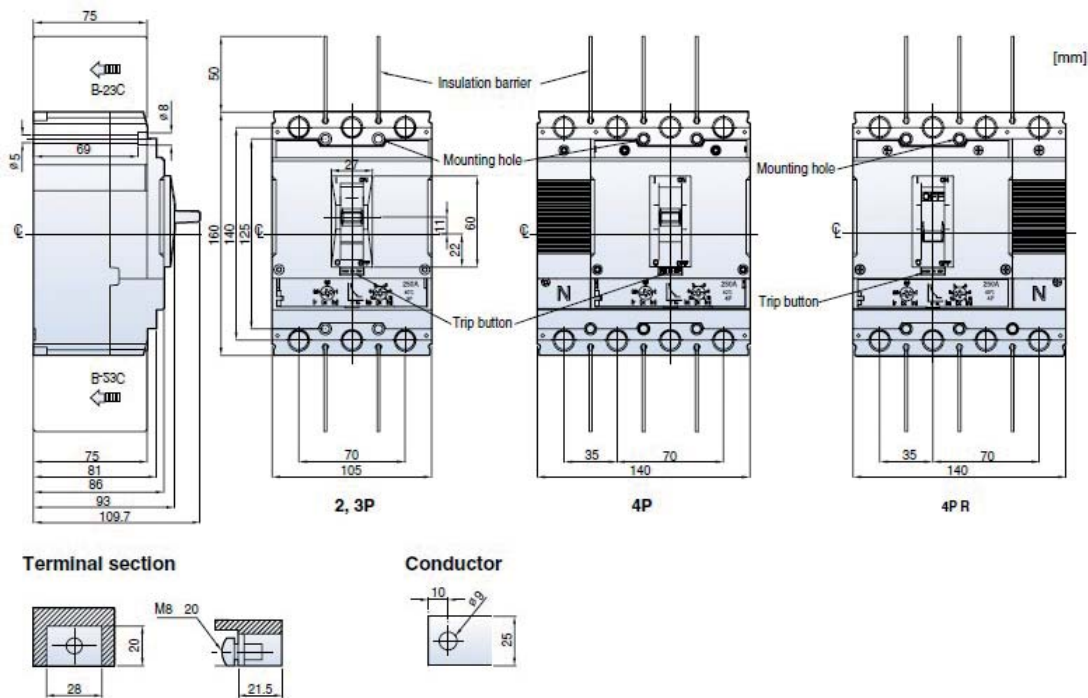

Loadline MCCB

YS3 Frame Electronic

Loadline

YS MCCB

Main Features

- Exceeds the requirements of EN 60947-2
- Electronic MCCBs have adjustable overload, short time delay and instantaneous trips
- Ultimate breaking capacities of 50kA, 85kA and 150kA at 380/415V AC
- $I_{cs} = 100\% I_{cu}$ for all ratings
- MCCBs have front connection terminals as standard
- Long-time overload protection adjusts between 0.4 to 1 x I_n
- Short-time overload protection adjusts between 1.5 to 10 x I_r
- Time delay adjusts between 0.05 and 0.3 seconds
- 4-pole MCCBs available with the neutral on the left or right hand side
- Rated Operational Voltage is 690V AC (U_e)
- Rated Insulation Voltage is 750V AC (U_i)
- Fully rated for use at 50°C



Current Rating (A)	3-Pole Product Code	4-Pole (N-Left) Product Code	4-Pole (N-Right) Product Code
YS3 Frame MCCB Electronic, $I_{cu} = 50kA$			
40	YS3H3P40E	YS3H4PL40E	YS3H4PR40E
80	YS3H3P80E	YS3H4PL80E	YS3H4PR80E
100	YS3H3P100E	YS3H4PL100E	YS3H4PR100E
160	YS3H3P160E	YS3H4PL160E	YS3H4PR160E
250	YS3H3P250E	YS3H4PL250E	YS3H4PR250E
YS3 Frame MCCB Electronic, $I_{cu} = 85kA$			
40	YS3K3P40E	YS3K4PL40E	YS3K4PR40E
80	YS3K3P80E	YS3K4PL80E	YS3K4PR80E
100	YS3K3P100E	YS3K4PL100E	YS3K4PR100E
160	YS3K3P160E	YS3K4PL160E	YS3K4PR160E
250	YS3K3P250E	YS3K4PL250E	YS3K4PR250E
YS3 Frame MCCB Electronic, $I_{cu} = 150kA$			
40	YS3R3P40E	YS3R4PL40E	YS3R4PR40E
80	YS3R3P80E	YS3R4PL80E	YS3R4PR80E
100	YS3R3P100E	YS3R4PL100E	YS3R4PR100E
160	YS3R3P160E	YS3R4PL160E	YS3R4PR160E
250	YS3R3P250E	YS3R4PL250E	YS3R4PR250E

YS3 Frame Dimensions

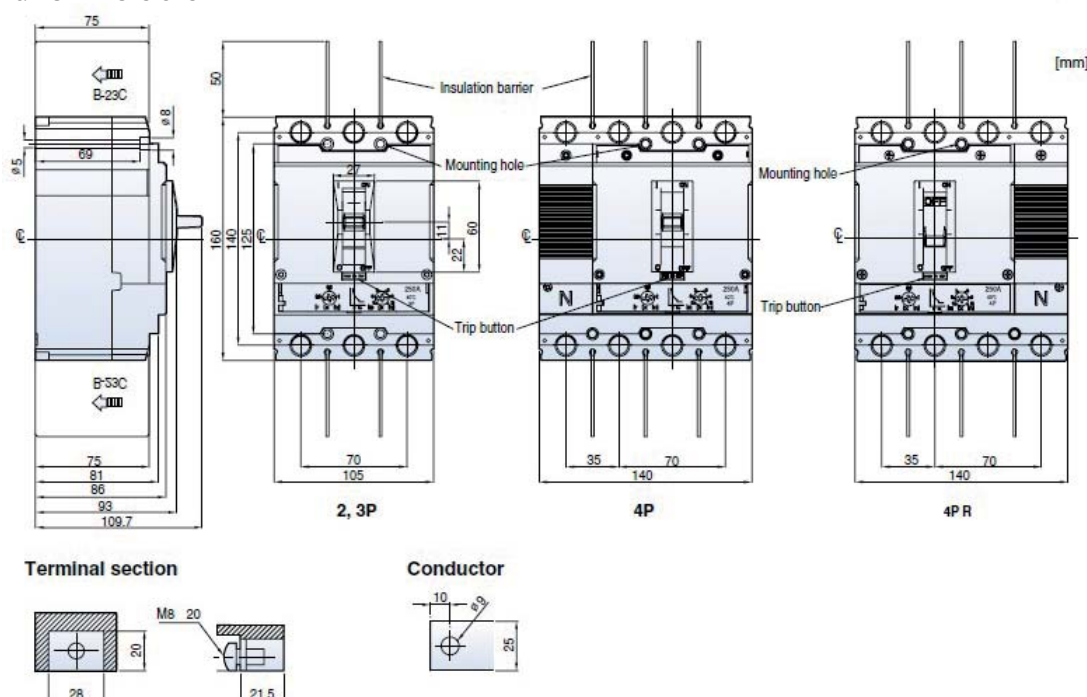

Loadline

YS MCCB

Loadline MCCB

YS5 Frame



Main Features

- Exceeds the requirements of EN 60947-2
- MCCBs have adjustable thermal and adjustable instantaneous trips
- Ultimate breaking capacities of 65kA, 85kA and 150kA at 380/415V AC
- Ics = 100% Icu for all ratings
- MCCBs have front connection terminals as standard
- Thermal adjustments are 0.8 x In, 0.9 x In and 1 x In
- Magnetic adjustments are between 5-10 x In
- 4-pole Switch Disconnectors and MCCBs available with neutral on the left or right hand side
- Rated Operational Voltage is 690V AC (Ue)
- Rated Insulation Voltage is 750V AC (Ui)
- Fully rated for use at 50°C

Current Rating (A)	3-Pole Product Code	4-Pole (N-Left) Product Code	4-Pole (N-Right) Product Code
Switch Disconnector			
400	YS5B3P400D	YS5B4PL400D	YS5B4PR400D
630	YS5B3P630D	YS5B4PL630D	YS5B4PR630D
YS5 Frame MCCB Adjustable Thermal / Adjustable Magnetic, Icu = 65kA			
300	YS5J3P300T	YS5J4PL300T	YS5J4PR300T
400	YS5J3P400T	YS5J4PL400T	YS5J4PR400T
500	YS5J3P500T	YS5J4PL500T	YS5J4PR500T
630	YS5J3P630T	YS5J4PL630T	YS5J4PR630T
YS5 Frame MCCB Adjustable Thermal / Adjustable Magnetic, Icu = 85kA			
300	YS5K3P300T	YS5K4PL300T	YS5K4PR300T
400	YS5K3P400T	YS5K4PL400T	YS5K4PR400T
500	YS5K3P500T	YS5K4PL500T	YS5K4PR500T
630	YS5K3P630T	YS5K4PL630T	YS5K4PR630T
YS5 Frame MCCB Adjustable Thermal / Adjustable Magnetic, Icu = 150kA			
300	YS5R3P300T	YS5R4PL300T	YS5R4PR300T
400	YS5R3P400T	YS5R4PL400T	YS5R4PR400T
500	YS5R3P500T	YS5R4PL500T	YS5R4PR500T
630	YS5R3P630T	YS5R4PL630T	YS5R4PR630T

YS5 Frame Dimensions

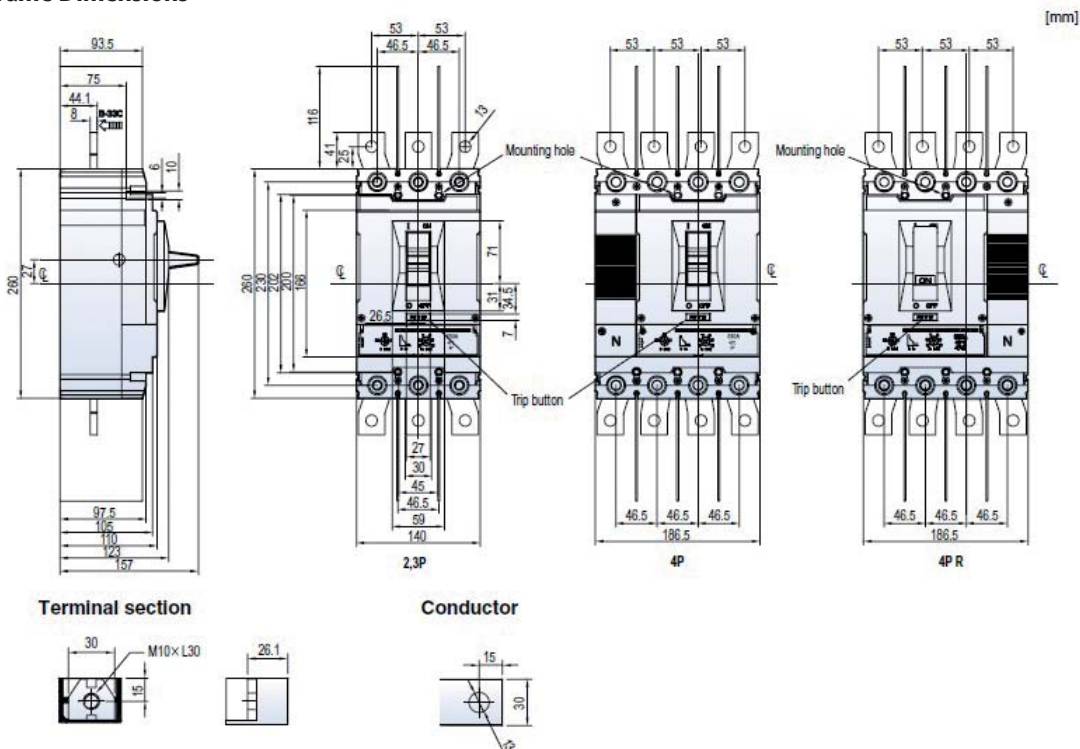

Loadline MCCB

YS5 Frame Electronic

Loadline

YS MCCB

Main Features

- Exceeds the requirements of EN 60947-2
- Electronic MCCBs have adjustable overload, short time delay and instantaneous trips
- Electronic MCCB with standard or multi-function control unit available
- Ultimate breaking capacities of 65kA, 85kA and 150kA at 380/415V AC
- $I_{cs} = 100\% I_{cu}$ for all ratings
- MCCBs have front connection terminals as standard
- Overload current adjustments are $I_r = 0.4$ to $1 \times I_n$
- Short time current adjustments are $I_{sd} = 1.5$ to $10 \times I_r$
- Time delay adjusts between 0.05 and 0.3 seconds
- 4-pole MCCBs available with the neutral on the left or right hand side
- Rated Operational Voltage is 690V AC (U_e)
- Rated Insulation Voltage is 750V AC (U_i)
- Fully rated for use at 50°C



Standard Control Unit

Current Rating (A)	3-Pole Product Code	4-Pole (N-Left) Product Code	4-Pole (N-Right) Product Code
YS5 Frame MCCB Electronic, $I_{cu} = 65kA$			
160	YS5J3P160E	YS5J4PL160E	YS5J4PR160E
250	YS5J3P250E	YS5J4PL250E	YS5J4PR250E
400	YS5J3P400E	YS5J4PL400E	YS5J4PR400E
630	YS5J3P630E	YS5J4PL630E	YS5J4PR630E
YS5 Frame MCCB Electronic, $I_{cu} = 85kA$			
160	YS5K3P160E	YS5K4PL160E	YS5K4PR160E
250	YS5K3P250E	YS5K4PL250E	YS5K4PR250E
400	YS5K3P400E	YS5K4PL400E	YS5K4PR400E
630	YS5K3P630E	YS5K4PL630E	YS5K4PR630E
YS5 Frame MCCB Electronic, $I_{cu} = 150kA$			
160	YS5R3P160E	YS5R4PL160E	YS5R4PR160E
250	YS5R3P250E	YS5R4PL250E	YS5R4PR250E
400	YS5R3P400E	YS5R4PL400E	YS5R4PR400E
630	YS5R3P630E	YS5R4PL630E	YS5R4PR630E

Multi-function Control Unit

Current Rating (A)	3-Pole Product Code	4-Pole (N-Left) Product Code	4-Pole (N-Right) Product Code
YS5 Frame MCCB Electronic, $I_{cu} = 65kA$			
160	YS5J3P160EM	YS5J4PL160EM	YS5J4PR160EM
250	YS5J3P250EM	YS5J4PL250EM	YS5J4PR250EM
400	YS5J3P400EM	YS5J4PL400EM	YS5J4PR400EM
630	YS5J3P630EM	YS5J4PL630EM	YS5J4PR630EM
YS5 Frame MCCB Electronic, $I_{cu} = 85kA$			
160	YS5K3P160EM	YS5K4PL160EM	YS5K4PR160EM
250	YS5K3P250EM	YS5K4PL250EM	YS5K4PR250EM
400	YS5K3P400EM	YS5K4PL400EM	YS5K4PR400EM
630	YS5K3P630EM	YS5K4PL630EM	YS5K4PR630EM
YS5 Frame MCCB Electronic, $I_{cu} = 150kA$			
160	YS5R3P160EM	YS5R4PL160EM	YS5R4PR160EM
250	YS5R3P250EM	YS5R4PL250EM	YS5R4PR250EM
400	YS5R3P400EM	YS5R4PL400EM	YS5R4PR400EM
630	YS5R3P630EM	YS5R4PL630EM	YS5R4PR630EM

Loadline MCCB

YS6 Frame



Main Features

- Exceeds the requirements of EN 60947-2
- MCCBs have adjustable thermal and adjustable instantaneous trips
- Ultimate breaking capacities of 65kA, 100kA and 150kA at 380/415V AC
- $I_{cs} = 100\% I_{cu}$ for all ratings
- MCCBs have front connection terminals as standard
- Thermal adjustments are $0.8 \times I_n$, $0.9 \times I_n$ and $1 \times I_n$
- Magnetic adjustments are between $5-10 \times I_n$
- 4-pole Switch Disconnectors and MCCBs available with neutral on the left or right hand side
- Rated Operational Voltage is 690V AC (U_e)
- Rated Insulation Voltage is 750V AC (U_i)
- Fully rated for use at 50°C

Current Rating (A)	3-Pole Product Code	4-Pole (N-Left) Product Code	4-Pole (N-Right) Product Code
Switch Disconnector			
800	YS6B3P800D	YS6B4PL800D	YS6B4PR800D
YS6 Frame MCCB Adjustable Thermal / Adjustable Magnetic, $I_{cu} = 65kA$			
800	YS6J3P800T	YS6J4PL800T	YS6J4PR800T
YS6 Frame MCCB Adjustable Thermal / Adjustable Magnetic, $I_{cu} = 100kA$			
800	YS6L3P800T	YS6L4PL800T	YS6L4PR800T
YS6 Frame MCCB Adjustable Thermal / Adjustable Magnetic, $I_{cu} = 150kA$			
800	YS6R3P800T	YS6R4PL800T	YS6R4PR800T

YS6 Frame Dimensions

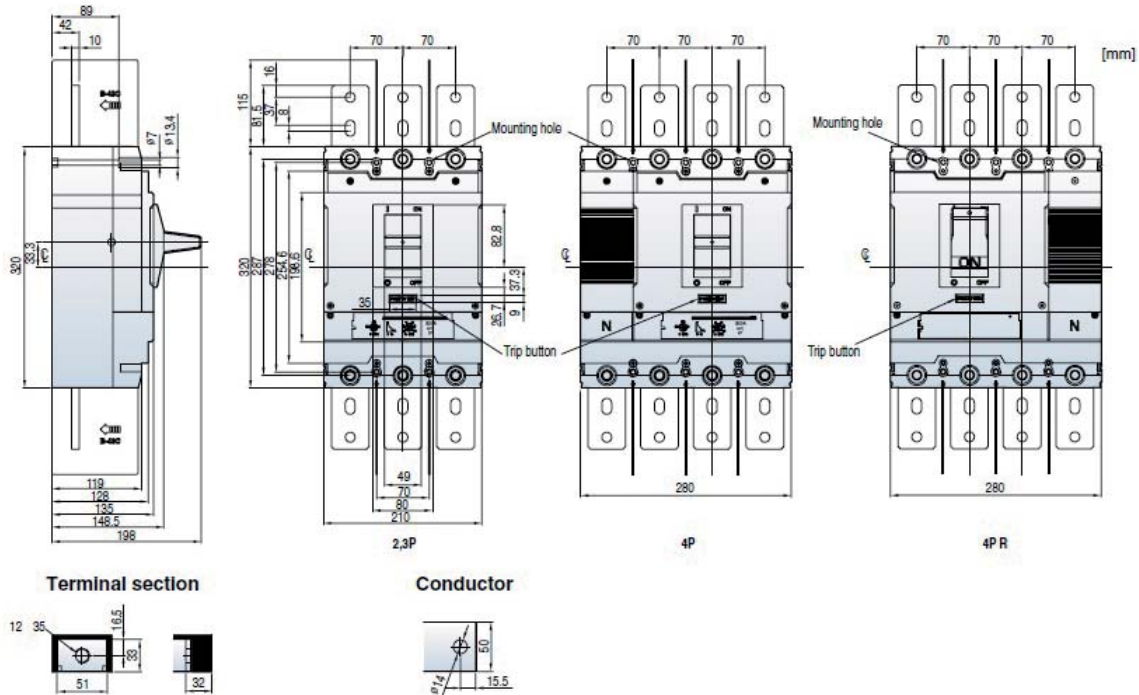

Loadline MCCB YS6 Frame Electronic

Loadline YS MCCB

Main Features

- Exceeds the requirements of EN 60947-2
- Electronic MCCBs have adjustable overload, short time delay and instantaneous trips
- Electronic MCCB with standard LSI or LSIG multi-function control units available
- Ultimate breaking capacities of 50kA, 85kA and 150kA at 380/415V AC
- $I_{cs} = 100\% I_{cu}$ for all ratings
- MCCBs have front connection terminals as standard
- Overload current adjustments are between $0.4 \times I_n$ to $1 \times I_n$
- Short time current adjustments available for LT, ST and GF
- Time delay adjustments between 0.05 to 3 seconds
- 4-pole MCCBs available with the neutral on the left or right hand side
- Rated Operational Voltage is 690V AC (U_e)
- Rated Insulation Voltage is 750V AC (U_i)
- Fully rated for use at 50°C



Standard Control Unit

Current Rating (A)	3-Pole Product Code	4-Pole (N-Left) Product Code	4-Pole (N-Right) Product Code
YS6 Frame MCCB Electronic, $I_{cu} = 50kA$			
630	YS6H3P630E	YS6H4PL630E	YS6H4PR630E
800	YS6H3P800E	YS6H4PL800E	YS6H4PR800E
YS6 Frame MCCB Electronic, $I_{cu} = 85kA$			
630	YS6K3P630E	YS6K4PL630E	YS6K4PR630E
800	YS6K3P800E	YS6K4PL800E	YS6K4PR800E
YS6 Frame MCCB Electronic, $I_{cu} = 150kA$			
630	YS6R3P630E	YS6R4PL630E	YS6R4PR630E
800	YS6R3P800E	YS6R4PL800E	YS6R4PR800E

Multi-function Control Unit

Current Rating (A)	3-Pole Product Code	4-Pole (N-Left) Product Code	4-Pole (N-Right) Product Code
YS6 Frame MCCB Electronic, $I_{cu} = 50kA$			
630	YS6H3P630EM	YS6H4PL630EM	YS6H4PR630EM
800	YS6H3P800EM	YS6H4PL800EM	YS6H4PR800EM
YS6 Frame MCCB Electronic, $I_{cu} = 85kA$			
630	YS6K3P630EM	YS6K4PL630EM	YS6K4PR630EM
800	YS6K3P800EM	YS6K4PL800EM	YS6K4PR800EM
YS6 Frame MCCB Electronic, $I_{cu} = 150kA$			
630	YS6R3P630EM	YS6R4PL630EM	YS6R4PR630EM
800	YS6R3P800EM	YS6R4PL800EM	YS6R4PR800EM

Loadline

YS MCCB



Loadline MCCB

YS2 to YS6 Frame Accessories

Description	3-Pole Product Code	4-Pole Product Code
Rear Terminals		
YS2 Rear Terminals (Round Type)	YS2RT3P	YS2RT4P
YS3 Rear Terminals (Round Type)	YS3RT3P	YS3RT4P
YS2 Rear Terminals (Flat Type)	YS2FT3P	YS2FT4P
YS3 Rear Terminals (Flat Type)	YS3FT3P	YS3FT4P
YS5 Rear Terminals (Flat Type)	YS5FT3P	YS5FT4P
YS6 Rear Terminals (Flat Type)	YS6FT3P	YS6FT4P
Terminal Protection		
YS2 Terminal Cover (For rear connection)	YS2TCS3P	YS2TCS4P
YS2 Terminal Cover (For front connection)	YS2TCL3P	YS2TCL4P
YS3 Terminal Cover (For rear connection)	YS3TCS3P	YS3TCS4P
YS3 Terminal Cover (For front connection)	YS3TCL3P	YS3TCL4P
YS5 Terminal Cover (For rear connection)	YS5TCS3P	YS5TCS4P
YS5 Terminal Cover (For front connection)	YS5TCL3P	YS5TCL4P
YS6 Terminal Cover (For rear connection)	YS6TCS3P	YS6TCS4P
YS6 Terminal Cover (For front connection)	YS6TCL3P	YS6TCL4P
YS2 / YS3 Interphase barrier (4 off)	YS23TB	
YS5 Interphase barrier (4 off)	YS5TB	
YS6 Interphase barrier (4 off)	YS6TB	
Cable Clamps		
YS2 Cable Clamps (3 x 3-pole and 4 x 4-pole)	YS2CC3P	YS2CC4P
YS3 Cable Clamps (3 x 3-pole and 4 x 4-pole)	YS3CC3P	YS3CC4P
YS5 Cable Clamps (3 x 3-pole and 4 x 4-pole)	YS5CC3P	YS5CC4P
Handle Locks		
YS2 Handle lock (3-pole & 4-pole only)	YS2DL1	YS2DL1
YS3 Handle lock (3-pole & 4-pole only)	YS3DL1	YS3DL1
YS5 Handle lock (3-pole & 4-pole only)	YS5DL1	YS5DL1
YS6 Handle lock (3-pole & 4-pole only)	YS6DL1	YS6DL1
Rotary Handles		
YS2 Direct Mounted Rotary Handle IP40	YS2DH	
YS2 Direct Mounted Rotary Handle with key lock IP40	YS2DHK	
YS2 Door Mounted Rotary Handle IP65 (585 mm)	YS2RH2	
YS3 Direct Mounted Rotary Handle IP40	YS3DH	
YS3 Direct Mounted Rotary Handle with key lock IP40	YS3DHK	
YS3 Door Mounted Rotary Handle IP65 (585 mm)	YS3RH2	
YS5 Direct Mounted Rotary Handle IP40	YS5DH	
YS5 Direct Mounted Rotary Handle with key lock IP40	YS5DHK	
YS5 Door Mounted Rotary Handle IP65 (645 mm)	YS5RH2	
YS6 Direct Mounted Rotary Handle IP40	YS6DH	
YS6 Direct Mounted Rotary Handle with key lock IP40	YS6DHK	
YS6 Door Mounted Rotary Handle IP65 (687 mm)	YS6RH2	
Plug-in Base		
YS2 Plug-in base IP20 (for 3-pole)	YS2PB3P	
YS3 Plug-in base IP20 (for 3-pole)	YS3PB3P	
YS5 Plug-in base IP20 (for 3-pole)	YS5PB3P	
YS6 Plug-in base IP20 (for 3-pole)	YS6PB3P	
Mechanical Interlocks		
YS2 Mechanical interlock	YS2MR3P	YS2MR4P
YS3 Mechanical interlock	YS3MR3P	YS3MR4P
YS5 Mechanical interlock	YS5MR3P	YS5MR4P
YS6 Mechanical interlock	YS6MR3P	YS6MR4P

Loadline MCCB

YS2 to YS6 Frame Accessories

Loadline

YS MCCB

Description	3-Pole Product Code	4-Pole Product Code
Residual Current Devices		
YS3 Residual current device	YS3RCD1	
YS5 Residual current device	YS5RCD1	
YS6 Residual current device	YS6RCD1	
Auxiliary and Alarm Switches *		
YS Auxiliary Switch Micro 1C Terminal (General Purpose)	YSAUX1	
YS Alarm Switch Micro 1C Terminal (General Purpose)	YSAL	
YS Fault Alarm Switch (General Purpose)	YSFAL	
Motors		
YS2 Motor Actuator 100-240V AC	YS2MA240AC	
YS2 Motor Actuator 100-220V DC	YS2MA220DC	
YS3 Motor Actuator 100-110V AC	YS3MA110AC	
YS3 Motor Actuator 240V AC	YS3MA240AC	
YS3 Motor Actuator 110V DC	YS3MA110DC	
YS3 Motor Actuator 220V DC	YS3MA220DC	
YS5 Motor Actuator 100-110V AC	YS5MA110AC	
YS5 Motor Actuator 240V AC	YS5MA240AC	
YS5 Motor Actuator 110V DC	YS5MA110DC	
YS5 Motor Actuator 220V DC	YS5MA220DC	
YS6 Motor Actuator 100-110V AC	YS6MA110AC	
YS6 Motor Actuator 240V AC	YS6MA240AC	
YS6 Motor Actuator 110V DC	YS6MA110VDC	
YS6 Motor Actuator 220V DC	YS6MA220VDC	
Shunt Trip *		
YS2-YS6 Shunt Trip 110-130V AC	YS26ST130AC	
YS2-YS6 Shunt Trip 200-240V AC	YS26ST240AC	
YS2-YS6 Shunt Trip 380-500V AC	YS26ST500AC	
YS2-YS6 Shunt Trip 24V DC	YS26ST24DC	
YS2-YS6 Shunt Trip 48V DC	YS26ST48DC	
YS2-YS6 Shunt Trip 110-130V DC	YS26ST130DC	
YS2-YS6 Shunt Trip 200-250V DC	YS26ST250DC	
Under-Voltage Release *		
YS2-YS6 Under-voltage release 110-130V AC	YS26UVR130AC	
YS2-YS6 Under-voltage release 200-240V AC	YS26UVR240AC	
YS2-YS6 Under-voltage release 380-440V AC	YS26UVR440AC	
YS2-YS6 Under-voltage release 110-130V DC	YS26UVR130DC	
YS2-YS6 Under-voltage release 200-250V DC	YS26UVR250DC	
YS2-YS6 Under-voltage release 380-440V DC	YS26UVR440DC	
Under-Voltage Release - Timed Delayed *		
YS2-YS6 Under-voltage release 200-250V AC	YS26UVR250AC-TD	
YS2-YS6 Under-voltage release 380-480V AC	YS26UVR480AC-TD	
YS2-YS6 Under-voltage release 48-60V DC	YS26UVR60DC-TD	
YS2-YS6 Under-voltage release 100-130V DC	YS26UVR130DC-TD	
YS2-YS6 Under-voltage release 200-250V DC	YS26UVR250DC-TD	

Note: Please be advised that the MCCB can be fitted with either a Shunt Trip or an Under-voltage release device. However the MCCB cannot house both of these devices together.

*Common Accessories for YS2, YS3, YS5 & YS6 frames



Loadline

YS MCCB



Loadline MCCB

YS8 Frame Electronic

Main Features

- Exceeds the requirements of EN 60947-2
- Electronic MCCBs have adjustable overload, short time delay and instantaneous trips
- Ultimate breaking capacities of 50kA, 70kA and 150kA at 380/415V AC
- Ics = 100% Icu for all ratings
- MCCBs have front connection terminals as standard
- Variety of Trip Relays available for adjustment, display and monitoring
- 4-pole MCCBs have the neutral on the left hand side only
- Rated Operational Voltage is 690V AC (Ue)
- Rated Insulation Voltage is 750V AC (Ui)
- Fully rated for use at 50°C

Current Rating (A)	3-Pole Product Code	4-Pole (N-Left) Product Code	Trip Relay Type
YS8 Frame MCCB Electronic, Icu = 50kA			
1000	YS8H3P1000ES	YS8H4PL1000ES	Standard
1000	YS8H3P1000EC	YS8H4PL1000EC	Current display
1000	YS8H3P1000ED	YS8H4PL1000ED	Power display
1000	YS8H3P1000EE	YS8H4PL1000EE	Enhanced Power display
1250	YS8H3P1250ES	YS8H4PL1250ES	Standard
1250	YS8H3P1250EC	YS8H4PL1250EC	Current display
1250	YS8H3P1250ED	YS8H4PL1250ED	Power display
1250	YS8H3P1250EE	YS8H4PL1250EE	Enhanced Power display
1600	YS8H3P1600ES	YS8H4PL1600ES	Standard
1600	YS8H3P1600EC	YS8H4PL1600EC	Current display
1600	YS8H3P1600ED	YS8H4PL1600ED	Power display
1600	YS8H3P1600EE	YS8H4PL1600EE	Enhanced Power display
YS8 Frame MCCB Electronic, Icu = 70kA			
1000	YS8K3P1000ES	YS8K4PL1000ES	Standard
1000	YS8K3P1000EC	YS8K4PL1000EC	Current display
1000	YS8K3P1000ED	YS8K4PL1000ED	Power display
1000	YS8K3P1000EE	YS8K4PL1000EE	Enhanced Power display
1250	YS8K3P1250ES	YS8K4PL1250ES	Standard
1250	YS8K3P1250EC	YS8K4PL1250EC	Current display
1250	YS8K3P1250ED	YS8K4PL1250ED	Power display
1250	YS8K3P1250EE	YS8K4PL1250EE	Enhanced Power display
1600	YS8K3P1600ES	YS8K4PL1600ES	Standard
1600	YS8K3P1600EC	YS8K4PL1600EC	Current display
1600	YS8K3P1600ED	YS8K4PL1600ED	Power display
1600	YS8K3P1600EE	YS8K4PL1600EE	Enhanced Power display
YS8 Frame MCCB Electronic, Icu = 150kA			
1000	YS8R3P1000ES	YS8R4PL1000ES	Standard
1000	YS8R3P1000EC	YS8R4PL1000EC	Current display
1000	YS8R3P1000ED	YS8R4PL1000ED	Power display
1000	YS8R3P1000EE	YS8R4PL1000EE	Enhanced Power display

Please see the following pages for further technical information regarding the types of accessories and Trip Relay types available.

Loadline MCCB

YS8 Frame Accessories

Loadline YS MCCB

Description	3-Pole Product Code	4-Pole Product Code
Terminal Connections		
YS8 Front connections (Flat Type)	YS8FT3PFC	YS8FT4PFC
YS8 Front connections (Vertical crimped type)	YS8CT3PFC	YS8CT4PFC
YS8 Rear connections (Flat Type)	YS8FT3PRC	YS8FT4PRC
YS8 Rear connections (Vertical crimped type)	YS8CT3PRC	YS8CT4PRC
Terminal Protection		
YS8 Interphase barrier (2 provided for 3-pole and 3 provided for 4-pole MCCB)	YS8TB3	YS8TB4
YS8 Interphase barrier extension terminals (2 provided for 3-pole and 3 provided for 4-pole MCCB)	YS8TBX3	YS8TBX4
Handle Locks		
YS8 Removable padlock	YS8DL	YS8DL
YS8 Fixed padlock	YS8DLF	YS8DLF
Rotary Handles		
YS8 Direct mounted rotary handle IP40 - Left	YS8DH-L	
YS8 Direct mounted rotary handle IP40 - Right	YS8DH-R	
YS8 Direct mounted rotary handle IP40 - Straight	YS8DH-S	
YS8 Direct mounted rotary handle IP40 with key lock - Left	YS8DHK-L	
YS8 Direct mounted rotary handle IP40 with key lock - Right	YS8DHK-R	
YS8 Direct mounted rotary handle IP40 with key lock - Straight	YS8DHK-S	
YS8 Door mounted rotary handle IP65 - Left (681mm)	YS8LH2	
YS8 Door mounted rotary handle IP65 - Right (681mm)	YS8RH2	
Mechanical Interlocks		
YS8 Mechanical interlock plate	YS8MIP	
Auxiliary and Alarm Switches		
YS8 Auxiliary switch (General Purpose)	YS8AUX	
YS8 Alarm switch (General Purpose)	YS8AL	
YS8 Fault Alarm switch (General Purpose)	YS8FAL	
Shunt Trip		
YS8 Shunt trip 100-130V AC	YS8ST130AC	
YS8 Shunt trip 200-250V AC	YS8ST250AC	
YS8 Shunt trip 380-480V AC	YS8ST480AC	
YS8 Shunt trip 24-30V DC	YS8ST24DC	
YS8 Shunt trip 48-60V DC	YS8ST60DC	
YS8 Shunt trip 100-130V DC	YS8ST130DC	
YS8 Shunt trip 200-250V DC	YS8ST250DC	
Under-Voltage Release		
YS8 Under-voltage release 200-250V AC	YS8UVR250AC	
YS8 Under-voltage release 380-480V AC	YS8UVR480AC	
YS8 Under-voltage release 100-130V DC	YS8UVR130DC	
YS8 Under-voltage release 200-250V DC	YS8UVR250DC	
Under-Voltage Controller - Time Delay *		
YS8 Under-voltage controller 200-250V AC	YS8UVR250AC-TD	
YS8 Under-voltage controller 380-480V AC	YS8UVR480AC-TD	
YS8 Under-voltage controller 48-60V DC	YS8UVR60DC-TD	
YS8 Under-voltage controller 100-130V DC	YS8UVR130DC-TD	
YS8 Under-voltage controller 200-250V DC	YS8UVR250DC-TD	

* Time Delay with Trip times of 0.5, 1.0, 1.5 & 3 Seconds.

Please specify time delay required. Controller to be used in conjunction with UVR.



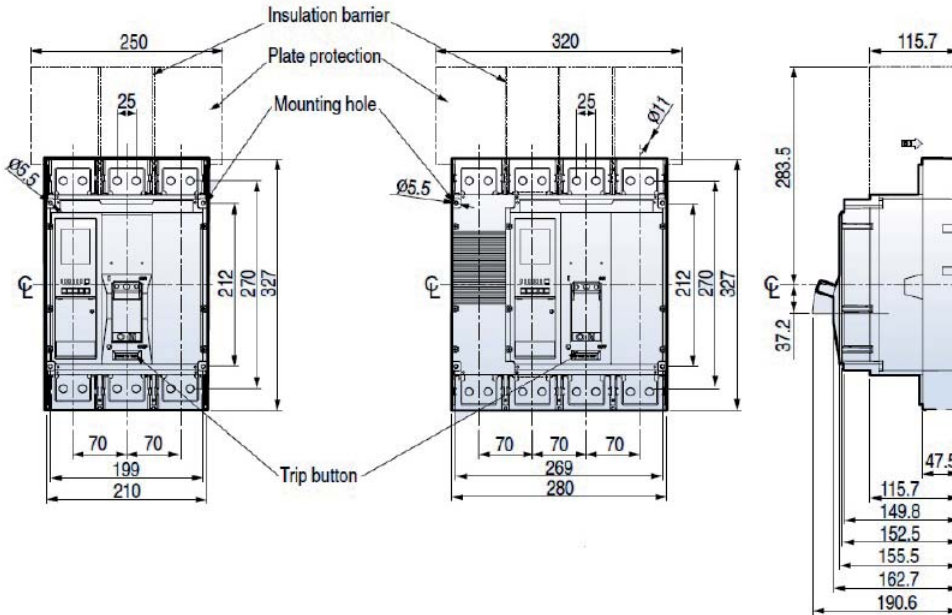
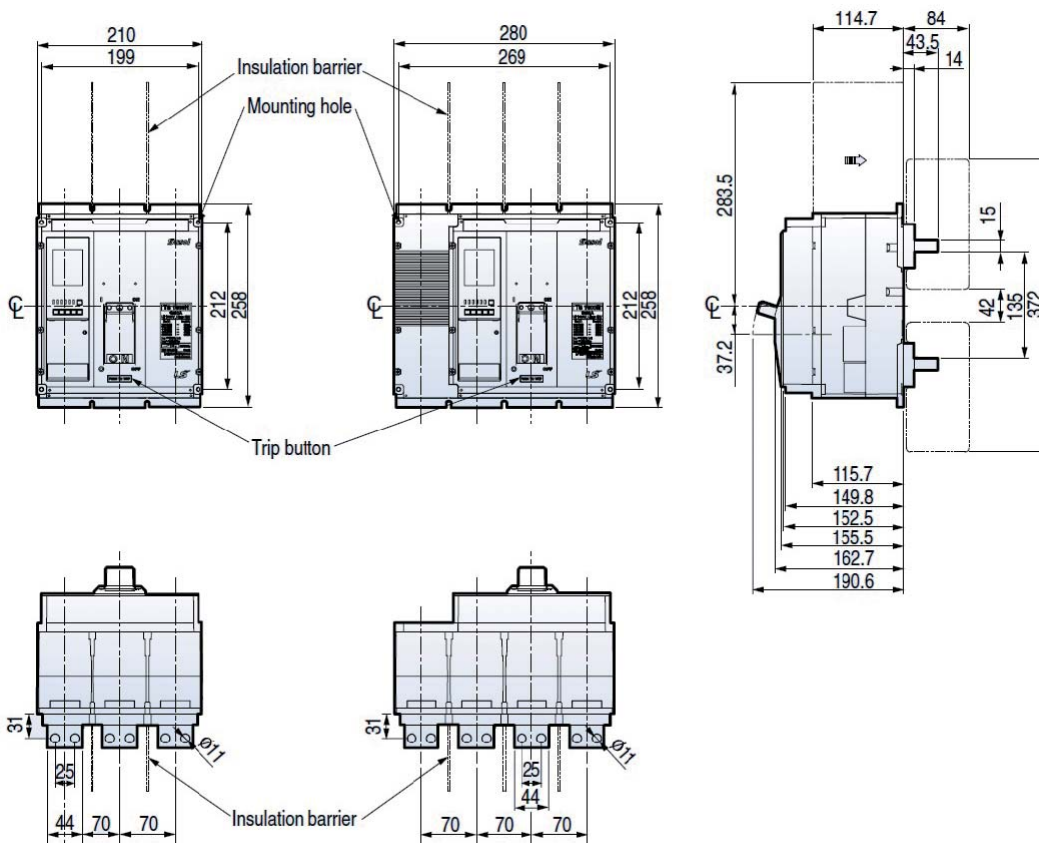



YS8 Frame Dimensions - Front Type

YS8 Frame Dimensions - Rear Type

Loadline MCCB

YS8 Frame Trip Relay Types

Loadline

YS MCCB

Trip Relay Type	Standard S Type	Current Display C Type	Power Display D Type	Enhanced Power Display E Type
Externals				
Current Protection	<ul style="list-style-type: none"> L/S/I/G/Thermal 	<ul style="list-style-type: none"> L/S/I/G/Thermal ZSI (Protective coordination) 	<ul style="list-style-type: none"> L/S/I/G/Thermal (Continuous) ZSI (Protective Coordination) 	<ul style="list-style-type: none"> L/S/I/G/Thermal (Continuous) ZSI (Protective Coordination)
Other Protection	-	<ul style="list-style-type: none"> Earth leakage (Option) 	<ul style="list-style-type: none"> Earth leakage (Option) Over/Under current Over/Under frequency Unbalance (Voltage/Current) Reverse power 	<ul style="list-style-type: none"> Earth leakage (Option) Over/Under current Over/Under frequency Unbalance (Voltage/Current) Reverse power
Measurement Function	-	<ul style="list-style-type: none"> Current (R/S/T/N) Pre Trip Alarm 	<ul style="list-style-type: none"> 3 Phase Voltage/Current RMS/Vector Power (P,Q,S), PF(3-Phase) Energy (Positive/Negative) Frequency, Demand 	<ul style="list-style-type: none"> 3 Phase Voltage/Current RMS/Vector Power (P,Q,S), PF (3 Phase) Energy (Positive/Negative) Frequency, Demand Volatge/Current harmonics (1st-63th) 3 Phase Waveforms THD, TDD, K-Factor
Fine Adjustment	-	-	<ul style="list-style-type: none"> Fine adjustment for long/short time delay/Instantaneous/ground 	<ul style="list-style-type: none"> Fine adjustment for long/short time delay/Instantaneous/ground
Pre Trip Alarm	-	-	<ul style="list-style-type: none"> Overload protection relays :DO (Alarm) (Ground fault is not available when using Pre trip alarm) 	<ul style="list-style-type: none"> Overload protection relays :DO (Alarm) (Ground fault is not available when using Pre trip alarm)
Digital Output	-	<ul style="list-style-type: none"> 3DO (Fixed) L, S/I, G Alarm 	<ul style="list-style-type: none"> 3DO (Programmable) trip, Alarm, General 	<ul style="list-style-type: none"> 3DO (Programmable) trip, Alarm, General
IDMTL setting	-	-	<ul style="list-style-type: none"> Compliance with IEC60255-3 SIT, VIT, EIT, DT 	<ul style="list-style-type: none"> Compliance with IEC60255-3 SIT, VIT, EIT, DT
Communication	-	<ul style="list-style-type: none"> Modbus/RS-485 Profibus - DP 	<ul style="list-style-type: none"> Modbus / RS-485 Profibus-DP 	<ul style="list-style-type: none"> Modbus / RS-485 Profibus-DP
Power Supply	<ul style="list-style-type: none"> Self Power - Power source works over 20% of load current 	<ul style="list-style-type: none"> Self Power - Power source works over 20% of load current - External power source are required for comm. AC/DC 100-250V DC 24-60V 	<ul style="list-style-type: none"> AC/DC 100-250V DC 24-60V Basic Protection function (L/S/I/G) is still under normal operation without control power 	<ul style="list-style-type: none"> AC/DC 100-250V DC 24-60V
RTC Timer	-	<ul style="list-style-type: none"> Available 	<ul style="list-style-type: none"> Available 	<ul style="list-style-type: none"> Available
LED for Trip info.	<ul style="list-style-type: none"> Long time delay Short time delay/Instantaneous Ground fault 	<ul style="list-style-type: none"> Long time delay Short time delay/Instantaneous Ground fault 	<ul style="list-style-type: none"> Long time delay Short time delay/Instantaneous Ground fault 	<ul style="list-style-type: none"> Long time delay Short time delay/Instantaneous Ground fault
Fault Recording	-	<ul style="list-style-type: none"> 10 records (Fault/Current/Date and Time) 	<ul style="list-style-type: none"> 256 records (Fault/Current /Date and Time) 	<ul style="list-style-type: none"> 256 records Last fault wave form recording (3 Phase)
Event Recording	-	-	<ul style="list-style-type: none"> 256 records (Content, Status, Date) 	<ul style="list-style-type: none"> 256 records (Content, Status, Date)
Operation Button	<ul style="list-style-type: none"> Reset button 	<ul style="list-style-type: none"> Reset, Menu Up/Down, Left/Right, Enter 	<ul style="list-style-type: none"> Reset, Menu Up/Down, Left/Right, Enter 	<ul style="list-style-type: none"> Reset, Menu Up/Down, Left/Right, Enter

Loadline MCCB

YM Frame MCCB Technical Data

Loadline

YM MCCB

Dorman Smith Frame Size		YM1			YM2	
MCCB Type or Sw. Disconnecter		Fixed MCCB	Fixed MCCB	Sw. Disc.	Fixed MCCB	Sw. Disc
Terminal Type		Front	Front	Front	Front	Front
Product Code		YM1B----TF	YM1N----TF	YM1B----D	YM2S----TF	YM2B----D
No of Poles		2,3,4	2,3,4	3,4	2,3,4	3,4
Nominal Current Ratings (In) (A) (50°C)		15, 20, 30, 40, 50, 60, 75, 100	15, 20, 30, 40, 50, 60, 75, 100	100	15, 20, 30, 40, 50, 60, 75, 100, 125	100, 125
Electrical Characteristics						
Rated Operational Voltage (Ue) (V)	AC 50/60Hz	690	690	690	690	690
	DC	500	500	500	500	500
Rated Insulation Voltage (Ui) (V)		750	750	750	750	750
Rated Impulse Withstand Voltage (Uimp) (kV)		8	8	8	8	8
Ultimate breaking capacity (Icu) (kA)	690V AC	5	7.5	-	8	-
IEC 60947-2	480/500V AC	10	14	-	26	-
	415/460V AC	18	26	-	37	-
	380V AC	22	30	-	42	-
	220/250V AC	35	50	-	85	-
	500V DC (3-pole)	10	15	-	20	-
	250V DC (2-pole)	10	15	-	20	-
Ics = % x Icu	%	100	75	-	100	-
Rated Frequency	Hz	50/60	50/60	50/60	50/60	50/60
Protection						
Fixed Thermal		Yes	Yes	-	Yes	-
Fixed Magnetic		Yes	Yes	-	Yes	-
Utilisation Category		A	A	A	A	A
Installation						
Front Connection		Standard	Standard	Standard	Standard	Standard
Extension Terminals		Optional	Optional	-	Optional	-
Rear Terminals		Optional	Optional	-	Optional	-
Plug-in		Optional	Optional	-	Optional	-
Dimensions						
Height (mm)		130	130	130	155	155
2 Pole Width (mm)		50	50	-	60	-
3 Pole Width (mm)		75	75	75	90	90
4 Pole Width (mm)		100	100	100	120	120
Depth (mm)		60	60	60	60	60
2 Pole Weight (kg)		0.5	0.5	-	0.7	-
3 Pole Weight (kg)		0.7	0.7	0.7	1	1
4 Pole Weight (kg)		0.9	0.9	0.9	1.2	1.2
Operation						
Panel mounted rotary handle		Optional	Optional	Optional	Optional	Optional
Direct mounted rotary handle		Optional	Optional	Optional	Optional	Optional
Mechanical Interlock						
Suitable for Isolation as per IEC 947-2		Yes	Yes	Yes	Yes	Yes
Endurance at 415V AC	Electrical (cycles)	10000	10000	10000	10000	10000
	Mechanical (cycles)	25000	25000	25000	25000	25000
Environment						
Operating Ambient Temperature	°C	-5 to +50	-5 to +50	-5 to +50	-5 to +50	-5 to +50
Relative Humidity	%	45-85	45-85	45-85	45-85	45-85
Altitude above Sea Level	Metres	<2000	<2000	<2000	<2000	<2000
Approval Marks						
CE		Yes	Yes	Yes	Yes	Yes
Terminals						
Terminals screw size		<50A is M5 >60A is M8	<50A is M5 >60A is M8	M8	M8	M8
Fixing screw size		M4 x 60	M4 x 60	M4 x 60	M4 x 60	M4 x 60
Standard cable termination (mm ²)		50	50	50	50	50
Maximum copper connection	W x D (mm)	<30A is 12.5 x 7 >40A is 15 x 7	<30A is 12.5 x 7 >40A is 15 x 7	15 x 7	16 x 8	16 x 8

Loadline MCCB

YM Frame MCCB Technical Data

Loadline

YM MCCB

YM3			YM5			YM6		
Fixed MCCB Front YM3N-----TF 2,3,4 100, 125, 150, 175, 200, 225, 250	Fixed MCCB Front YM3S-----TF 2,3,4 100, 125, 150, 175, 200, 225, 250	Sw. Disc. Front YM3B-----D 3,4 125, 150, 200, 250	Fixed MCCB Front YM5S-----TF 3,4 250, 300, 350, 400	Fixed MCCB Front YM5H-----TF 3,4 250, 300, 350, 400	Sw. Disc. Front YM5B-----D 3,4 250, 400	Fixed MCCB Front YM6S-----TF 3,4 500, 630, 700, 800	Fixed MCCB Front YM6J-----TF 3,4 500, 630, 700, 800	Sw. Disc. Front YM6B-----D 3,4 400, 800
690	690	690	690	690	690	690	690	690
500	500	500	500	500	500	500	500	500
750	750	750	750	750	750	750	750	750
8	8	8	8	8	8	8	8	8
8	8	-	5	8	-	8	10	-
18	26	-	18	35	-	25	45	-
26	37	-	37	50	-	37	65	-
30	42	-	42	65	-	45	75	-
65	85	-	50	75	-	50	85	-
10	20	-	10	20	-	10	20	-
10	20	-	10	20	-	10	20	-
100	100	-	100	100	-	100	100	-
50/60	50/60	50/60	50/60	50/60	50/60	50/60	50/60	50/60
Yes	Yes	-	Yes	Yes	-	Yes	Yes	-
Yes	Yes	-	Yes	Yes	-	Yes	Yes	-
A	A	A	A	A	A	A	A	A
Standard	Standard	Standard	Standard	Standard	Standard	Standard	Standard	Standard
Optional	Optional	-	Optional	Optional	-	Optional	Optional	-
Optional	Optional	-	Optional	Optional	-	Optional	Optional	-
Optional	Optional	-	Optional	Optional	-	Optional	Optional	-
165	165	165	257	257	257	280	280	280
105	105	-	-	-	-	-	-	-
105	105	105	140	140	140	210	210	210
140	140	140	184	184	184	280	280	280
60	60	60	109	109	109	109	109	109
1.1	1.1	-	-	-	-	-	-	-
1.2	1.2	1.2	6.2	6.2	6.2	11.5	11.5	11.5
1.6	1.6	1.6	7.8	7.8	7.8	18.2	18.2	18.2
Optional	Optional	Optional	Optional	Optional	Optional	Optional	Optional	Optional
Optional	Optional	Optional	Optional	Optional	Optional	Optional	Optional	Optional
Yes	Yes	Yes	Yes	Yes	Yes	Yes	Yes	Yes
10000	10000	10000	1000	1000	1000	500	500	500
25000	25000	25000	4000	4000	4000	2500	2500	2500
-5 to +50	-5 to +50	-5 to +50	-5 to +50	-5 to +50	-5 to +50	-5 to +50	-5 to +50	-5 to +50
45-85	45-85	45-85	45-85	45-85	45-85	45-85	45-85	45-85
<2000	<2000	<2000	<2000	<2000	<2000	<2000	<2000	<2000
Yes	Yes	Yes	Yes	Yes	Yes	Yes	Yes	Yes
M8	M8	M8	M10	M10	M10	M12	M12	M12
M4 x 55	M4 x 55	M4 x 55	M6 x 100	M6 x 100	M6 x 100	M6 x 100	M6 x 100	M6 x 100
95	95	95	150	150	150	240	240	240
25 x 10	25 x 10	25 x 10	30 x 10	30 x 10	30 x 10	40 x 10	40 x 10	40 x 10

Loadline MCCB YM Frame Time / Current Curves

Loadline YM MCCB

YMI Frame Time / Current Curves

Rated current: 3-30A

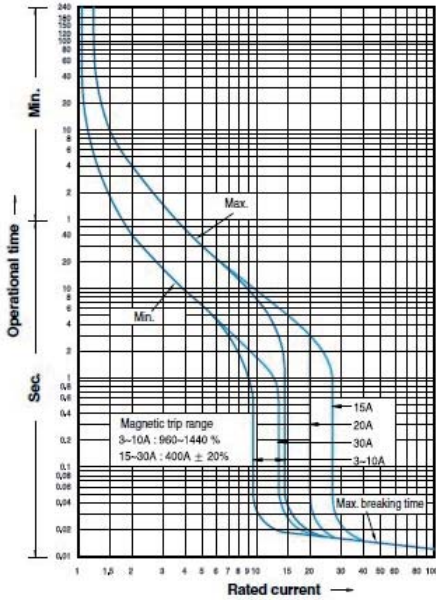

Rated current: 40-100A

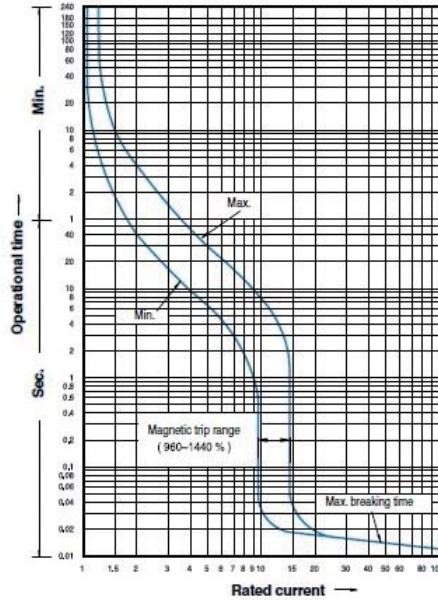

Compensation curves

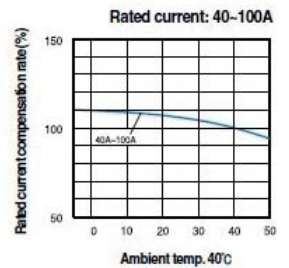
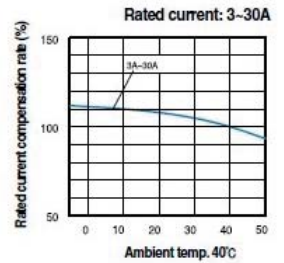

YM2 Frame Time / Current Curves

Rated current: 15-30A, 40-100A

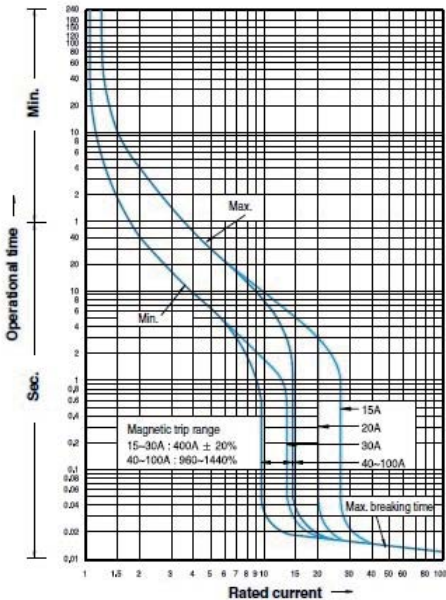

Rated current: 125A

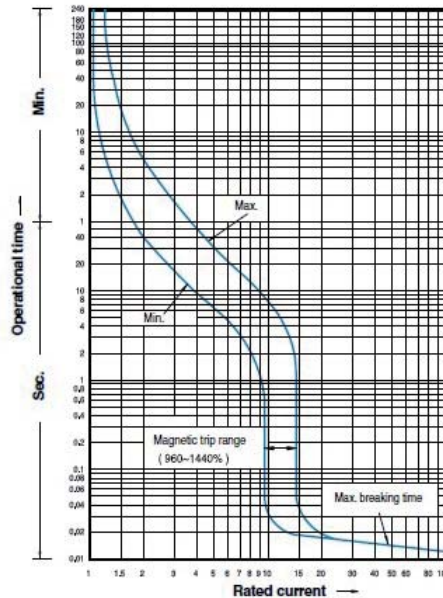

Compensation curves

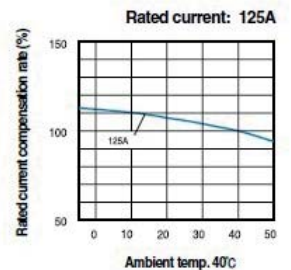
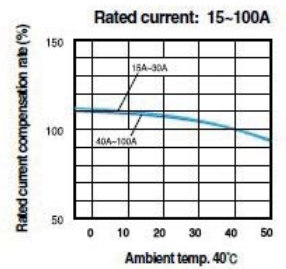

Loadline MCCB

YM Frame Time / Current Curves

YM3 Frame Time / Current Curves

Rated current: 100-225A

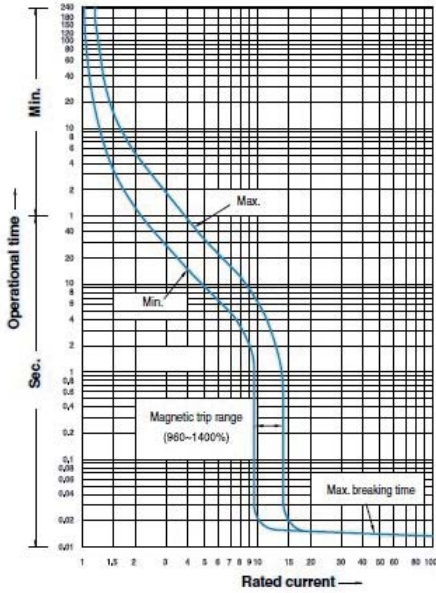

Rated current: 250A

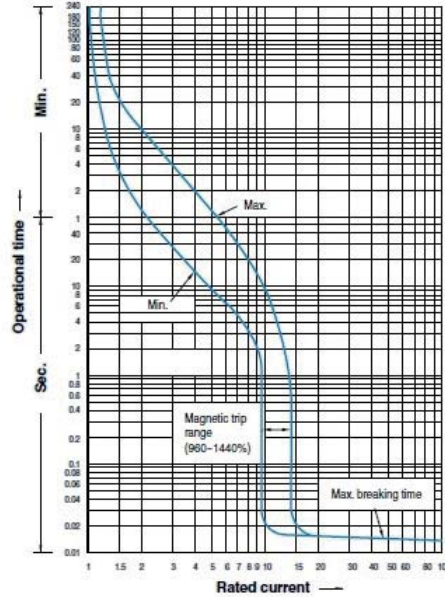

Compensation curves

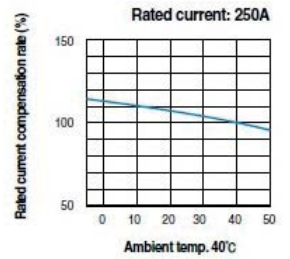
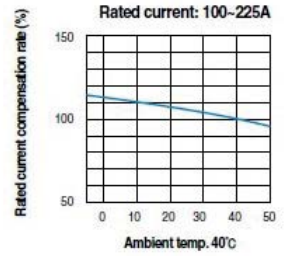

YM5 and YM6 Frame Time / Current Curves

Rated current: 250-400A

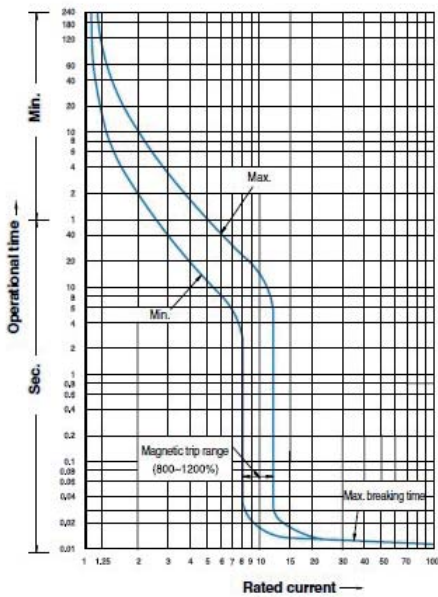

Rated current: 500-800A

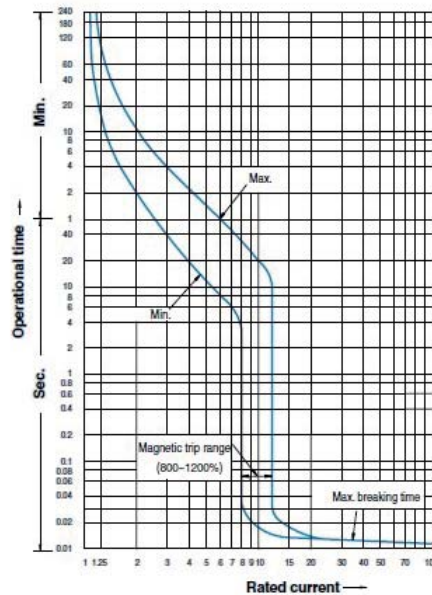

Compensation curves

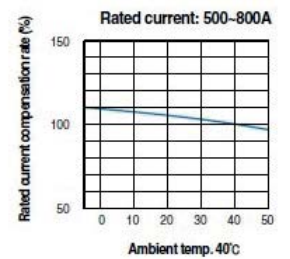
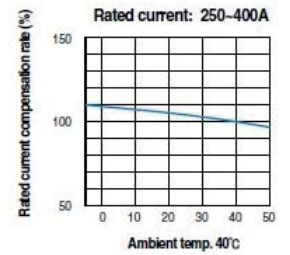

Loadline MCCB

YS Frame MCCB Technical Data

Loadline

YS MCCB

Dorman Smith Frame Size		YS2			YS3		
MCCB Type or Sw. Disconnecter		MCCB	MCCB	MCCB	MCCB	MCCB	MCCB
Terminal Type		Front	Front	Front	Front	Front	Front
Product Code		YS2H	YS2K	YS2R	YS3H	YS3K	YS3R-
No of Poles		3, 4	3, 4	3, 4	*1, 3, 4	3, 4	3, 4
Nominal Current Ratings (In) (A) (50°C)		16, 20, 25, 32, 40, 50, 63, 80, 100, 125, 160	16, 20, 25, 32, 40, 50, 63, 80, 100, 125, 160	16, 20, 32, 40, 50, 63, 80, 100, 125, 160	40, 50, 63, 80, 100, 125, 160, 200, 250	40, 50, 63, 80, 100, 125, 160, 200, 250	40, 50, 63, 80, 100, 125, 160, 200, 250
Electrical Characteristics							
Rated Operational Voltage (Ue) (V)	AC 50/60Hz	690	690	690	690 (1P 240)	690	690
	DC	500	500	500	500 (1P 250)	500	500
Rated Insulation Voltage (Ui) (V)		750	750	750	750	750	750
Rated Impulse Withstand Voltage (Uimp) (kV)		8	8	8	8	8	8
Ultimate breaking capacity (Icu) (kA)	660/690V AC	5	5	10	10	15	20
	480/500V AC	30	50	65	42	65	85
IEC 60947-2	440/460V AC	50	70	130	50	70	130
	380/415V AC	50	85	150	50	85	150
	220/240V AC	85	100	200	100 (1P 30)	120	200
	500V DC (2-poles in series)	42	65	100	50	85	100
	250V DC	42	65	100	50	85	100
Ics = % x Icu	%	100	100	100	100	100	100
Rated Frequency	Hz	50/60	50/60	50/60	50/60	50/60	50/60
Protection (Trip Units)							
Fixed Thermal Fixed Magnetic (TF)		Yes	Yes	Yes	Yes	Yes	Yes
Adjustable Thermal Fixed Magnetic (TA)		Yes	Yes	Yes	Yes (1P N/A)	Yes	Yes
Adjustable Thermal Adjustable Magnetic (T)		No	No	No	Yes (1P N/A)	Yes	Yes
Electronic Standard (E)		No	No	No	Yes (1P N/A)	Yes	Yes
Electronic Multifunction (EM)		No	No	No	No	No	No
Utilisation Category		A	A	A	A	A	A
Installation							
Front Connection		Standard	Standard	Standard	Standard	Standard	Standard
Rear Terminals		Optional	Optional	Optional	Optional (1P N/A)	Optional	Optional
Plug-in		Optional	Optional	Optional	Optional (1P N/A)	Optional	Optional
Residual Current Device					Optional (1P N/A)	Optional	Optional
Dimensions							
Height (mm)		140	140	140	160 (1P 140)	160	160
3 Pole Width (mm)		90	90	90	105 (1P 35)	105	105
4 Pole Width (mm)		120	120	120	140	140	140
Depth (mm)		86	86	86	86	86	86
3 Pole Weight (kg)		1.5	1.5	1.5	2 (1P 0.57)	2	2
4 Pole Weight (kg)		1.8	1.8	1.8	2.6	2.6	2.6
Operation							
Panel mounted rotary handle		Optional	Optional	Optional	Optional	Optional	Optional
Direct mounted rotary handle		Optional	Optional	Optional	Optional (1P N/A)	Optional	Optional
Mechanical Interlock		Optional	Optional	Optional	Optional (1P N/A)	Optional	Optional
Suitable for Isolation as per IEC 947-2		Yes	Yes	Yes	Yes	Yes	Yes
Endurance at 415V AC	Electrical (cycles)	10000	10000	10000	10000	10000	10000
	Mechanical (cycles)	25000	25000	25000	25000	25000	25000
Environment							
Operating Ambient Temperature	°C			-5 to +50	-5 to +50	-5 to +50	-5 to +50
Relative Humidity	%			45-85	45-85	45-85	45-85
Altitude above Sea Level	Metres			<2000	<2000	<2000	<2000
Approval Marks							
CE		Yes	Yes	Yes	Yes	Yes	Yes
Terminals							
Terminals screw size		M8 x 20	M8 x 20	M8 x 20	M8 x 20	M8 x 20	M8 x 20
Fixing screw size		M4 x 75	M4 x 75	M4 x 75	M4 x 75	M4 x 75	M4 x 75

* 1P MCCB YS3 Frame Icu=30kA at 220 / 240V AC with current ratings from 16A to 160A.

** MCCB YS6 with current rating of 630A available with Electronic trip unit.

Loadline MCCB

YS Frame MCCB Technical Data

Loadline

YS MCCB

YS5			YS6			YS8		
MCCB Front YS5J 3, 4 300, 400, 500, 630	MCCB Front YS5K 3, 4 300, 400, 500, 630	MCCB Front YS5R 3, 4 300, 400, 500, 630	MCCB Front YS6J 3, 4 **800	MCCB Front YS6L 3, 4 **800	MCCB Front YS6R 3, 4 **300	MCCB Front YS8H 3, 4 800, 1000, 1250, 1600	MCCB Front YS8K 3, 4 800, 1000, 1250, 1600	MCCB Front YS8R 3, 4 800, 1000
690	690	690	690	690	690	690	690	690
500	500	500	500	500	500	-	-	-
750	750	750	750	750	750	1000	1000	1000
8	8	8	8	8	8	8	8	8
10	20	35	10	20	35	35	45	50
42	65	85	42	85	100	40	50	100
65	85	130	65	100	130	50	65	130
65	85	150	65	100	150	50	70	150
100	120	200	100	120	200	55	75	200
50	85	100	50	85	100	-	-	-
50	85	100	50	85	100	-	-	-
100	100	100	100	100	100	100	75	100
50/60	50/60	50/60	50/60	50/60	50/60	50/60	50/60	50/60
Yes	Yes	Yes	Yes	Yes	Yes	No	No	No
Yes	Yes	Yes	Yes	Yes	Yes	No	No	No
Yes	Yes	Yes	Yes	Yes	Yes	No	No	No
Yes	Yes	Yes	Yes	Yes	Yes	No	No	No
Yes	Yes	Yes	Yes	Yes	Yes	Yes	Yes	Yes
A	A	A	A	A	A	B	B	A
Standard	Standard	Standard	Standard	Standard	Standard	Standard	Standard	Standard
Optional	Optional	Optional	Optional	Optional	Optional	Optional	Optional	Optional
Optional	Optional	Optional	Optional	Optional	Optional	-	-	-
Optional	Optional	Optional	Optional	Optional	Optional	-	-	-
260	260	260	320	320	320	327	327	327
140	140	140	210	210	210	210	210	210
186.5	186.5	186.5	280	280	280	280	280	280
110	110	110	135	135	135	152.5	152.5	152.5
5.4	5.4	5.4	15.1	15.1	15.1	13	13	13
7.2	7.2	7.2	19.6	19.6	19.6	16.8	16.8	16.8
Optional	Optional	Optional	Optional	Optional	Optional	Optional	Optional	Optional
Optional	Optional	Optional	Optional	Optional	Optional	Optional	Optional	Optional
Optional	Optional	Optional	Optional	Optional	Optional	-	-	-
Yes	Yes	Yes	Yes	Yes	Yes	Yes	Yes	Yes
6000	6000	6000	3000	3000	3000	2000-5000	2000-5000	3000
20000	20000	20000	10000	10000	10000	10000	10000	4000
-5 to +50	-5 to +50	-5 to +50	-5 to +50	-5 to +50	-5 to +50	-5 to +50	-5 to +50	-5 to +50
45-85	45-85	45-85	45-85	45-85	45-85	45-85	45-85	45-85
<2000	<2000	<2000	<2000	<2000	<2000	<2000	<2000	<2000
Yes	Yes	Yes	Yes	Yes	Yes	Yes	Yes	Yes
M10 x 30	M10 x 30	M10 x 30	M12 x 35	M12 x 35	M12 x 35	2 x M10 Studs	2 x M10 Studs	2 x M10 Studs
M5 x 85	M5 x 85	M5 x 85	M6 x 100	M6 x 100	M6 x 100	M5 x 110	M5 x 110	M5 x 110

YS2 Frame Time / Current Curves

Thermal / Magnetic 16A to 100A

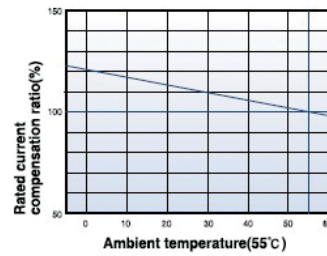
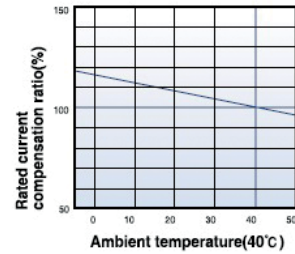
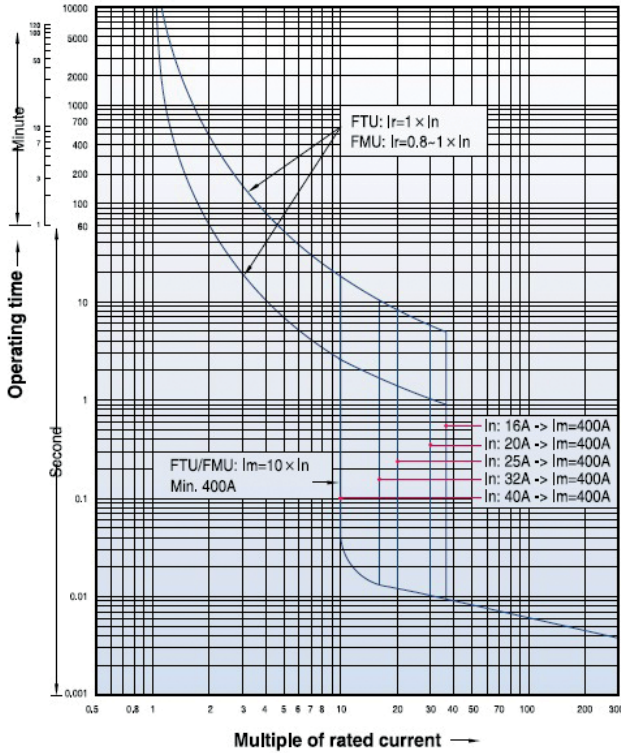

Thermal / Magnetic 125A to 160A

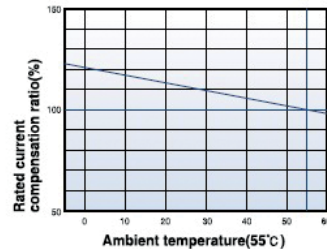
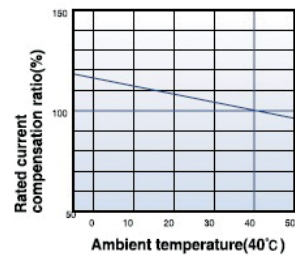
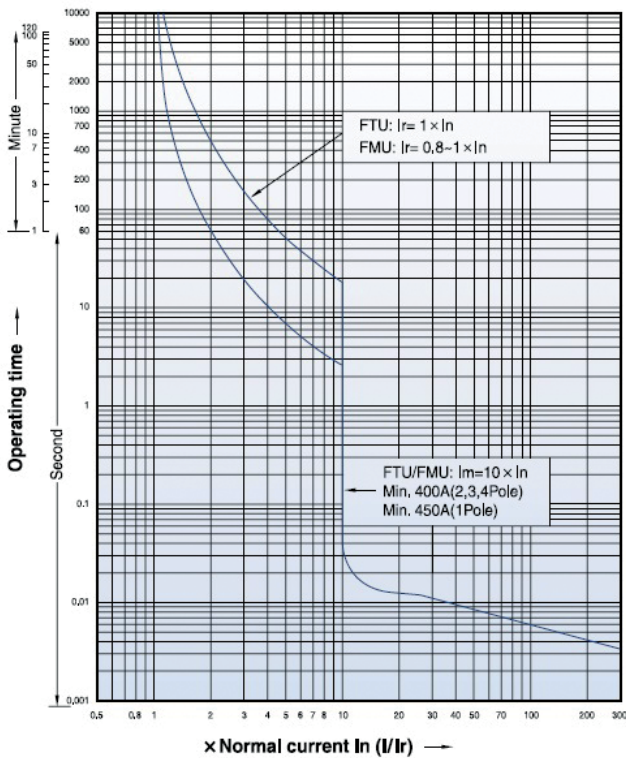

Loadline MCCB

YS Frame Time / Current Curves

Loadline

YS MCCB

YS3 Frame Time / Current Curves

Thermal / Magnetic 40A to 100A

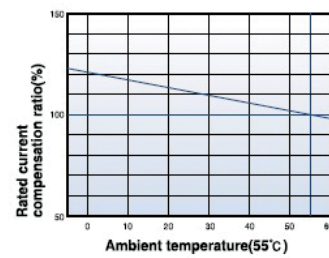
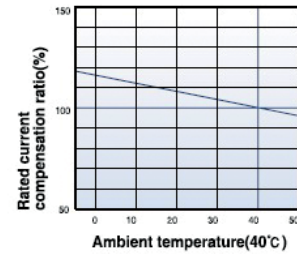
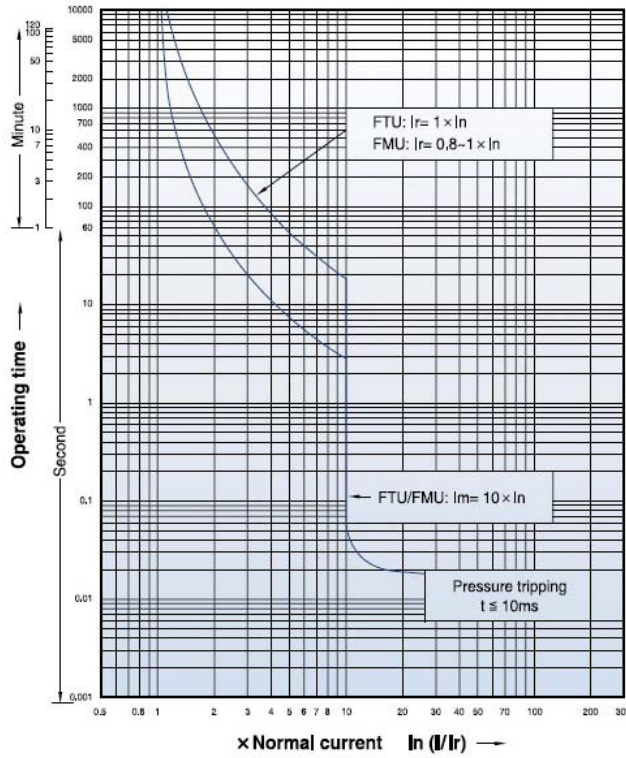

Thermal / Magnetic 125A to 160A

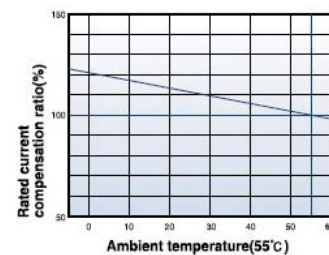
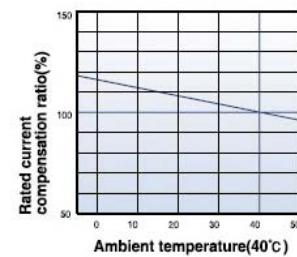
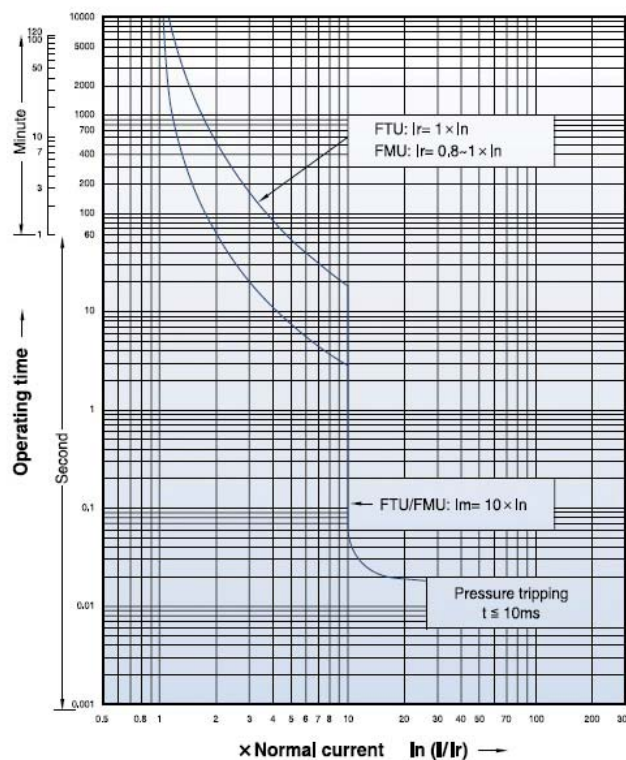

YS3 Frame Time / Current Curves

Thermal / Magnetic 200A to 250A

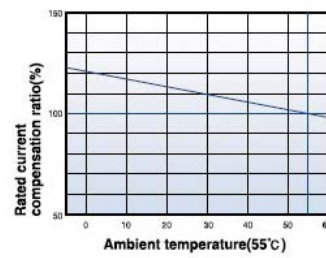
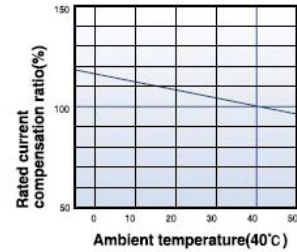
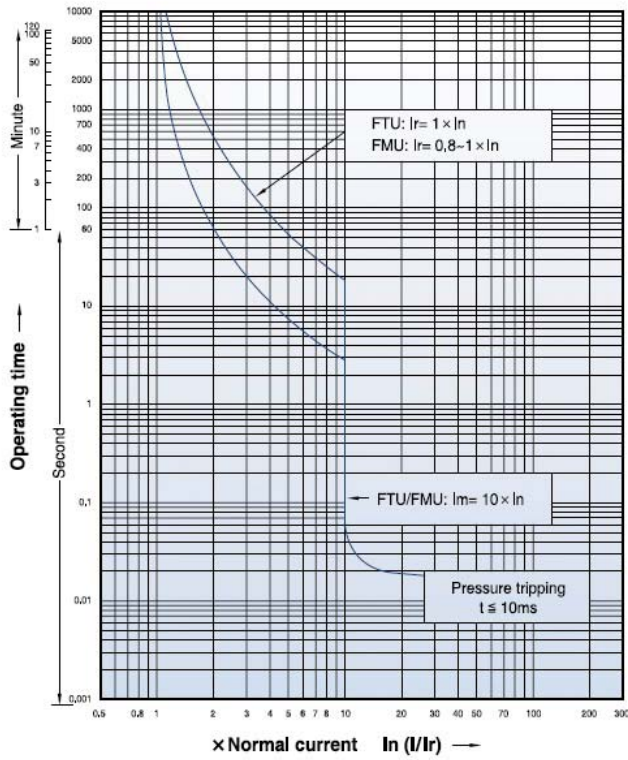

Loadline MCCB

YS Frame Time / Current Curves

Loadline

YS MCCB

YS5 Frame Time / Current Curves

Thermal / Magnetic 400A

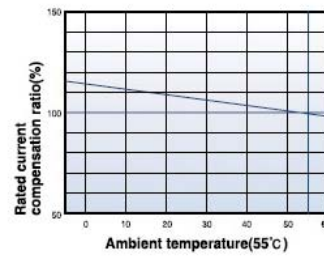
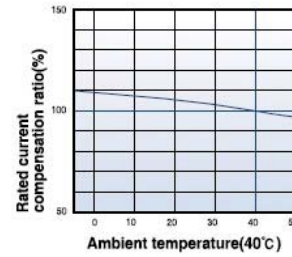
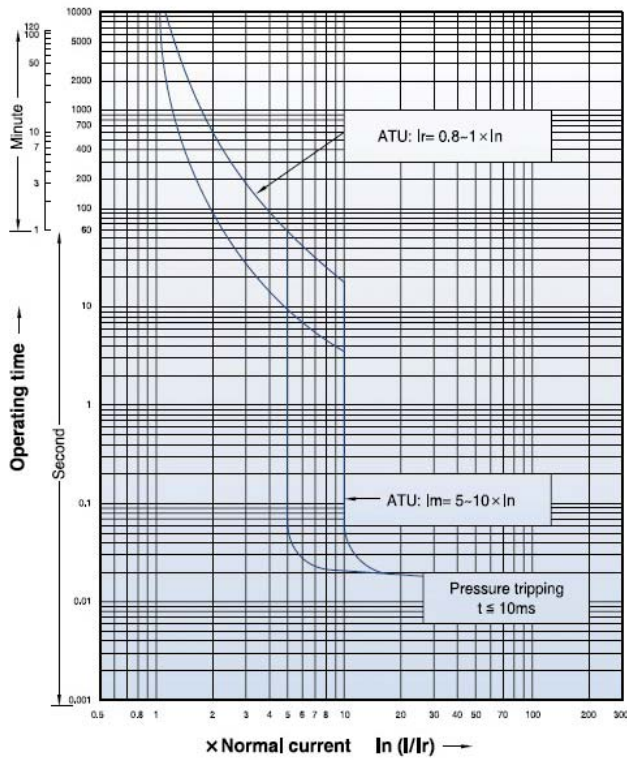

Thermal / Magnetic 630A

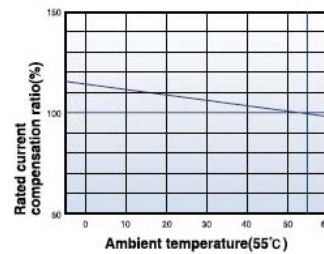
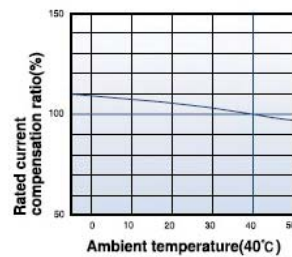
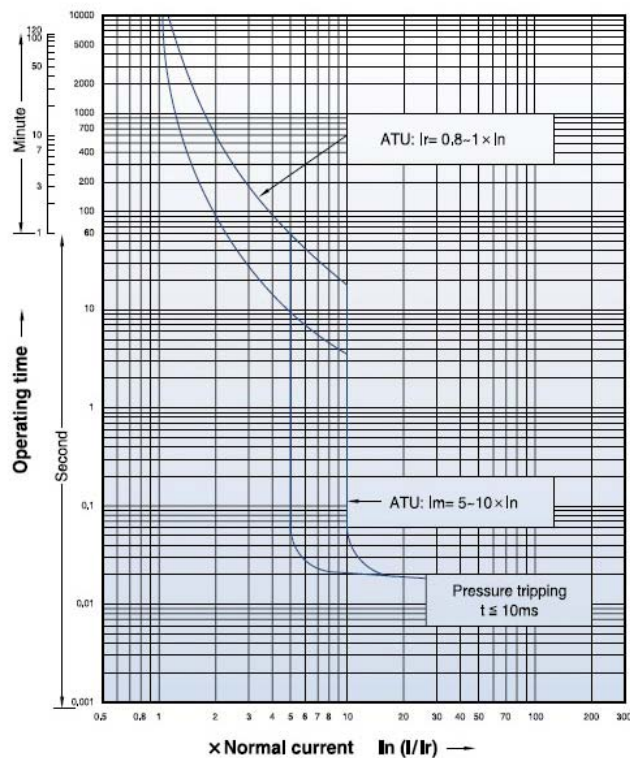

YS6 Frame Time / Current Curves

Thermal / Magnetic 800A

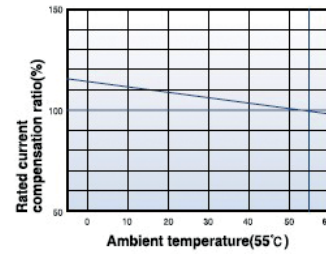
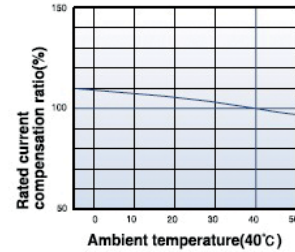
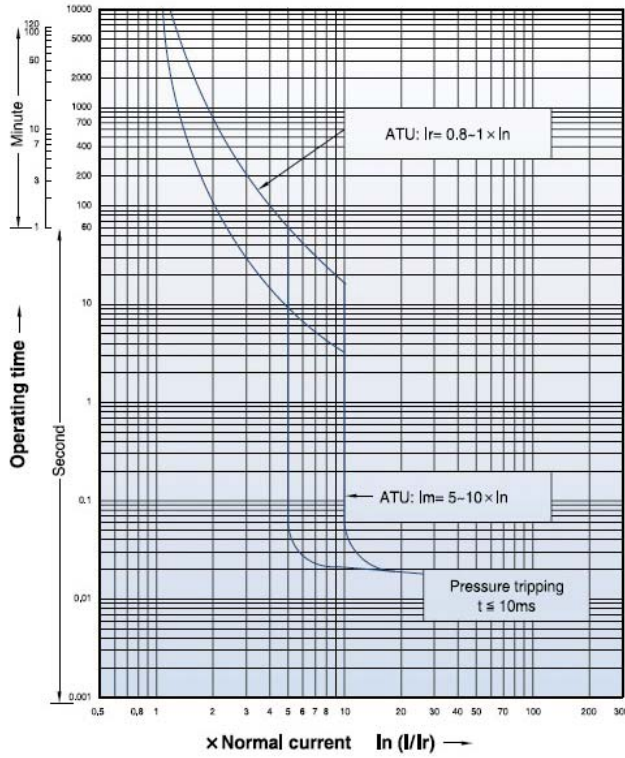

YS2 to YS6 Frame Time / Current Curves

Electronic – L / S / I function

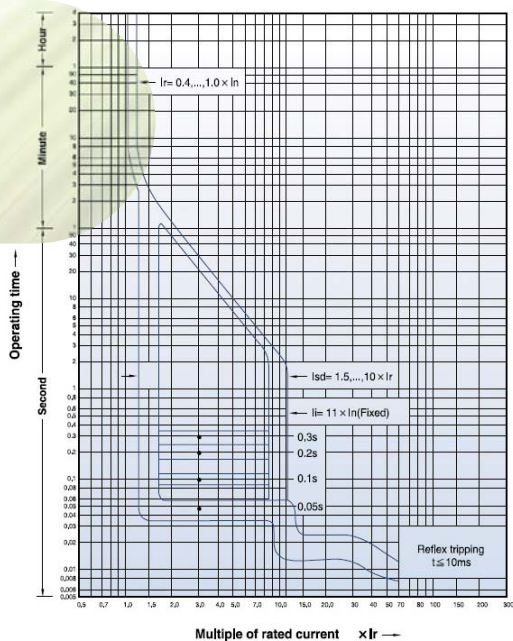

YS5 to YS6 Frame Time / Current Curves

Electronic – L / S / I function with ammeter, communications and zone selective interlocking

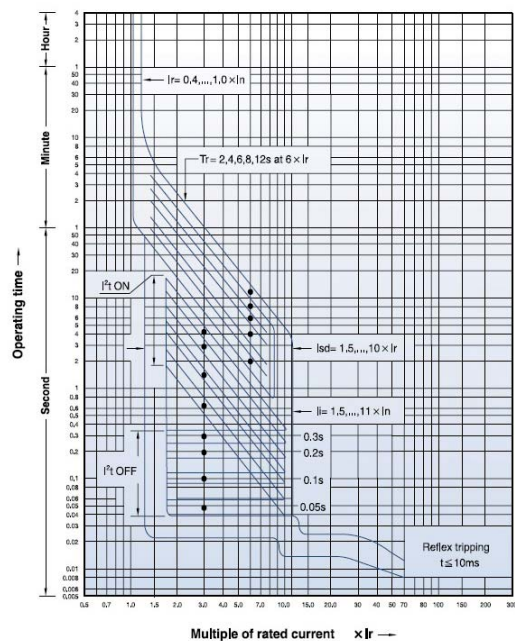

Loadline MCCB

YS Frame Time / Current Curves

Loadline
YS MCCB

YS8 Frame Time / Current Curves

Electronic 800A to 1600A

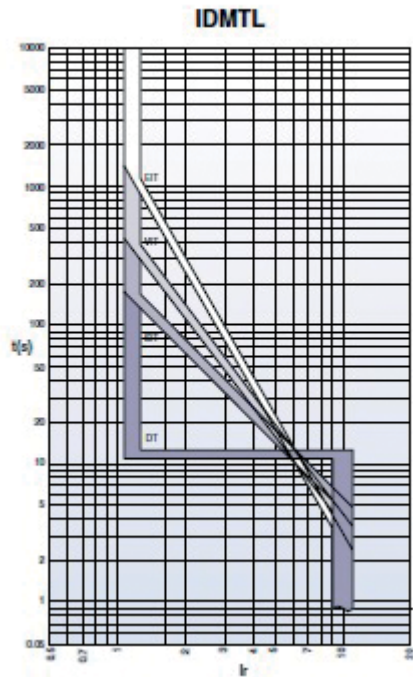
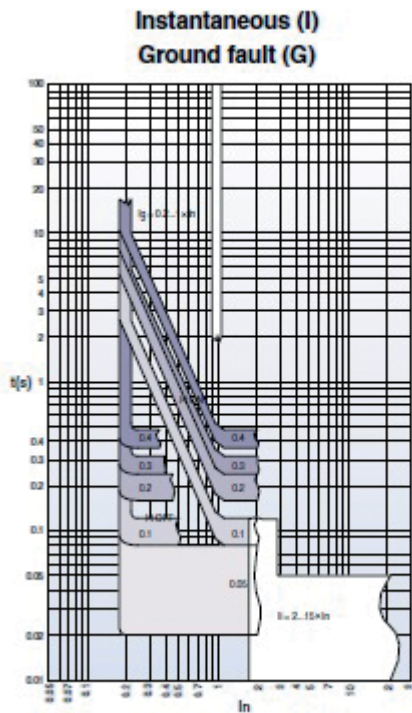
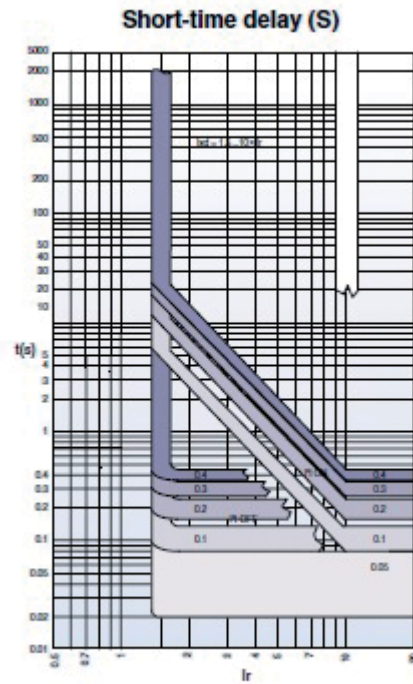
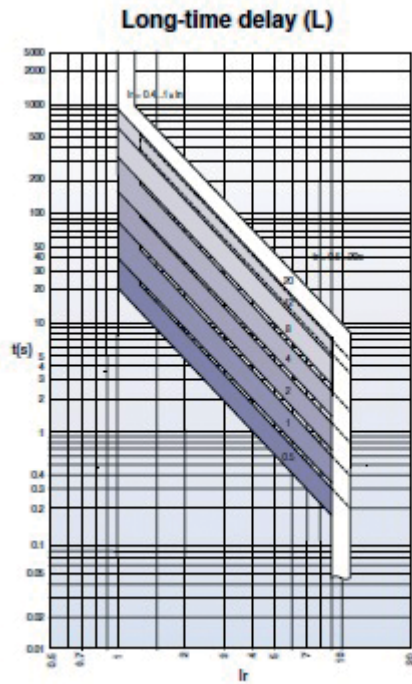

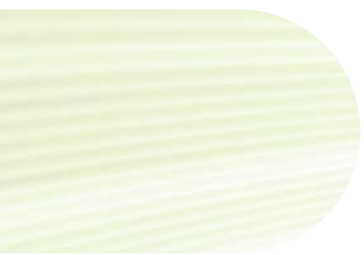

**BRAINTREE, UK**

Dorman Smith Switchgear Limited
8 Swinbourne Drive
Springwood Industrial Estate
Braintree, Essex
CM7 2YG
Tel: +44 (0) 844 225 1063
Fax: +44 (0) 844 225 1064
Email: sales@dormansmith.co.uk
www.dormansmithswitchgear.com

PRESTON, UK

Dorman Smith Switchgear Limited
1 Nile Close
Nelson Court Business Centre
Ashton on Ribble
Preston, Lancashire
PR2 2XU
Tel: +44 (0) 1772 325380
Fax: +44 (0) 1772 325385
Email: sales@dormansmith.co.uk
www.dormansmithswitchgear.com

DUBAI, U.A.E.

Dorman Smith Switchgear LLC
P.O. Box 12872
Dubai
U.A.E.
Tel: +971 4 3470226
Fax: +971 4 3470002
Email: dsdubai@dormansmith.co.uk
www.dormansmithswitchgear.com

DOHA, QATAR

Dorman Smith Switchgear WLL
P.O. Box 40249
Doha
Qatar
Tel: +974 55717161
Fax: +974 44514989

MUSCAT, OMAN

Dorman Smith Switchgear
P.O. Box 143, P.C. 101
Al Wattayah
Sultanate of Oman
Tel: +968 24562534/24562394
Fax: +968 24562830

For further information or to request one of our product catalogues please contact us from the information above. E&OA. Whilst every effort has been made to ensure accuracy, no liability is accepted for the consequences of any error or omissions in this catalogue. Dorman Smith Switchgear Ltd. reserve the right to change or amend any technical specification or product detail without prior notification.